



AUTOMOTIVE SOLUTIONS

ENGLISH



190100693

MED 11.5 LW

MAY 2014

APPROVAL NUMBER

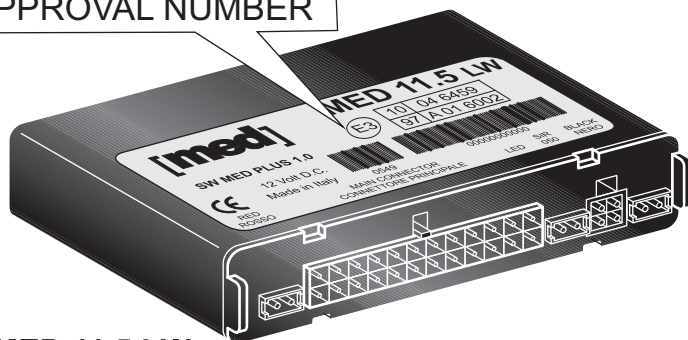

MED 11.5 LW



PC PROGRAMMING
ONLY WITH

SW MED PLUS

KIT SK PLUS

CHD 400



OPTIONAL

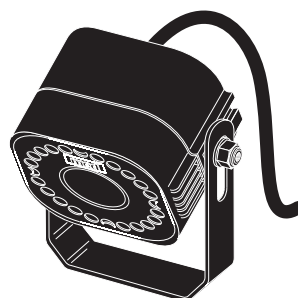

SIR 050
SIR 070.LW

ORIGINAL REMOTE CONTROLLED MODULAR ALARM

WITH BUILT-IN RECEIVER FOR **MED LW** WIRELESS MODULES

SIR 070.LW IS THE MED SELF-POWERED WIRELESS SIREN.

MED 11.5 LW CAN CONTROL THE CENTRAL LOCKING READY TO VEHICLES.

USER'S GUIDE

COMPANY
WITH QUALITY SYSTEM
CERTIFIED BY
BUREAU VERITAS
ISO 9001:2008

A.E.B. S.p.A. a socio unico / a single member Company - Via dell'Industria, 20
42025 - Corte Tegge - Cavriago (RE) - Italy
med è una divisione di / a division of A.E.B. S.p.A. www.medautomotive.it
Ph.+39 0522 494486 - Fax +39 0522 494410 - e-mail: service@medautomotive.it



QUICK WORKING INSTRUCTIONS

WARNING:

- These instructions are referred to the system completely installed.
- The other opening parts will also be indicated as doors, for example: hatch doors, windows, storage compartments, bonnet, boot, etc.
- In the instructions are included all the other versions of **MED 11.5** such as, for example, **MED 11.5 CE** with **CHD 400** electronic key.
- The direction indicators can be connected to give the optical signals when the system alarms. In some vehicles they can give also the “service signals” and the system “activation / desactivation” signals in addition to the LED and the **SIR 050** or **SIR 070.LW** buzzer.
- Is possible to use the new med remote control as the TX 4000 LW (hereinafter referred to as TX LW) or TX PAR LW, to activate / deactivate the system: they can also open / close the doors, the windows closing drive, manage additional optional modules (features dependent on the characteristics of the vehicle, from the connections made and the additional modules installed).
- The “original remote control” indication includes both the remote control with the keys to be pressed to open / close the vehicle and the latest generation devices with which you merely have to touch the handle of the vehicle to get in, or start the engine with the “START” button, defined by the vehicle manufacturers as KEY LESS GO, INTELLIGENT KEY, etc.

SYSTEM ACTIVATION BY THE REMOTE CONTROL

WITH ULTRASONIC SENSOR, WINDOWS CLOSING AND MODULES:

Lock the vehicle with the original remote control, as indicated by the manufacturer of the vehicle.

In alternative, with **med** remote control:

TX LW = press the button **once**.

TX PAR LW = press the button  **once**.

Confirmation: **2 LED** (red pilot lamp) and direction indicators **flashings**, **2 two-tone signals** of the buzzer (with SIR 050 / SIR 070), doors locking, windows closing, LED lit fixed, then flashing with active ultrasonic sensor.

WARNING: **3 flashings**, **3 two-tone signals**, doors locking, windows closing, **LED immediately flashing** indicate the activation without ultrasonic sensor (definitive cutting out).

3 flashings, **3 two-tone signals**, doors locking, windows closing, **LED fixedly switched on, then blinking** mean the arming with out buttons reading (doors, bonnet, boot) and / or additional modules cut out.

WITHOUT ULTRASONIC SENSOR, WINDOWS CLOSING AND MODULES CUT OUT:

Turn the ignition key off or open a door with the ignition key turned off, then while the LED is lit, hold the button down until the two-tone acoustic confirmation signal is given (LED off with the button pressed). Then lock the vehicle with the original remote control.

Cutout continues until the panel key is turned ON [+15] again.

In alternative, with **med** remote control:

TX LW = press in quick succession the button twice.

TX PAR LW = press the button  **once**.

Confirmation: **4 short flashings** LED and direction indicators, **4 two-tone signals** of the buzzer, doors locking, LED immediately flashing.

SYSTEM DESACTIVATION

Open the vehicle with the original remote control, as indicated by the manufacturer of the vehicle. For the vehicles having a separate boot-opening button: usually even this button allows the alarm system desactivation; only for some vehicles, due to the original working, the doors need to be opened before, then the boot.

In alternative, with **med** remote control:

TX LW = press the button **once**.

TX PAR LW = press the button  **once**.

WARNING: Press **1 time** the button of the remote control or **2 times** in fast sequence (only for those cars where the double manual control opens the driver's door first, and then the passengers' ones).

Confirmation: **long flashing** LED and direction indicators, **1 extended signal** of the buzzer, doors opening, LED switched off (with closed doors; for some vehicles LED on).

On some vehicles, the ignition of the [+15] ON done with the original key starter can turn the alarm off, making the function of "emergency key".

In these cases, the car must be recognized code of the transponder in the key content as their own, by disabling the immobilizer original, similar to the use of remote control series, which send the corresponding signals on the CAN line to the central MED 11.5 LW.

It 'also possible, through the installer to configure the system so that the remote turn off the alarm, but only the use of CHD 400 (optional) allows starting the engine and permanently disable the alarm.

If any anomalies or alarms occurred, the first alarm is shown by some additional signalings (BEEPS) of the siren and by some LED flashings:

- 1 Doors, bonnet, boot openings detected on "CAN" line.
- 2 Contact key [+15] ON.
- 3 Ultrasonic sensor (it detects all kind of intrusions in the vehicle).
- 4 Doors, bonnet, boot and additional modules on delayed analogical line (LIGHT BLUE / WHITE wire - IN 1).
- 5 Anti-tampering of the ultrasonic sensor (anti-blinding / anti-masking).
- 6 Doors, bonnet, boot on instantaneous analogical line (LIGHT BLUE wire - IN 2).
- 7 Contact key [+15] ON detected on "CAN" line.
- 9 Opening the doors, windows and storage compartments detected by wireless contacts MIC LW, MIC MEC LW.
- 10 Opening the doors, windows, storage compartments detected by chokable wireless contacts: MIC LW, MIC MEC LW, infrared sensors SEN INFRA LW, SEN INFRA 360 LW.
- 11 Gas sensor SEN GAS LW.
- 12 The boot lid opens, if separately detected on the "CAN" line (or only 1 signal).
- 13 The bonnet lid opens, if separately detected on the "CAN" line (or only 1 signal).
- 14 The bonnet lid opens, if separately detected on the wireless electronic siren SIR 070 LW.
- 15 Cut out power wireless electronic siren SIR 070 LW.

The alarm memory is repeated if the system is activated and desactivated without turning the contact key on [+15] ON.

It's cancelled only by turning the contact key [+15] ON.

To simplify the use of the system, we always suggest the pairing of the electronic key **CHD 400** (allowing the system activation / desactivation without the remote control and the vehicle start).

We offer a complete range of accessories designed specifically to be paired with this alarm control unit, which prove useful to complete the protection system, such as the following for example: wireless sensors with magnetic contact MIC LW or mechanical contact MIC MEC LW for protecting doors, windows and storage compartments; infrared sensors SEN INFRA LW (mounted on sides) or SEN INFRA 360 LW (mounted on internal roof); wireless sensor that detects soporific gas or LPG (Liquefied Petroleum Gas or rather Butane and Propane): SEN GAS LW; auxiliary acoustic indicators and the telephone alarm repeater, the satellite protection systems controlled by both the Control Centre and also self-sufficiently by the vehicle owner.

Ask your MED installer for more.

WARNING:

- The installer has to give to the vehicle owner the **PIN CARD**, **THESE USER'S GUIDE** and the **INSTALLATION CERTIFICATE** duly filled out and signed, that is valid as product warranty (to keep on board).
- The central unit has to be installed by skilled personnel.
- Some functions may exclude others.
Some depend directly on the equipment of the vehicle and on the accessories installed.
- The maximum transmission range of the wireless sensors (roughly 10 meters) is reduced in the presence of strong radiofrequency disturbance and also if the built-in battery should run low.
- Follow the instructions below to replace the battery.
- A.E.B. S.p.A. declines all responsibility and suspends the warranty in case of any inappropriate use of the product, in case of tampering or pairing with inappropriate devices.
- Position the control unit and the wireless sensors inside the vehicle, away from heat sources and protected against the infiltration of liquids or condensate; the wires must lead up to the control unit from below.
- A.E.B. S.p.A. reserves the right to bring any kind of improvements without previous notice.
- The **MED 11.5 LW** and the wireless siren **SIR 070.LW** can be installed in **24 Vdc** vehicles with the **KIT 24V** potential divider.

DENIAL ON ACTIVATION

- With the contact key in on position, the central unit ignores the remote control and the electronic key.
- **3 BEEPS** and **3 flashings** of the LED mean that the door, the bonnet or the boot are opened and the buttons is connected to instantaneous input (LIGHT BLUE wire - IN 2) or detected by the CAN line.

Close the door and activate the system again.

If the alarm is activate on the closing doors the 3 BEEPS are followed by a long continuous buzzer BEEP that ends only when all doors are closed.

The alarm is activated automatically.

- System activation by electronic key CHD 400 or the buttons is connected to delayed input (LIGHT BLUE/WHITE wire - IN 1), and the door is not closed, the system is activated, then after the pre set delay time (standard **30 / 50** seconds) the system carries out an alarm cycle.
- **5 BEEPS** and **5 flashings** of the LED mean that the system is OUT OF ORDER.
PROGRAM the system to activate it again.

PANIC FUNCTION

Using the transmitter **TX PAR LW** you can activate an alarm cycle with the siren, turn signals and supplementary warning devices in the case of a dangerous situation.

Press the button of the **TX PAR LW** with the symbol  for **2 / 3** seconds consecutively until the alarm cycle starts.

The alarm is interrupted by pressing the panic button or the de-activation button of the **TX PAR LW**, using the electronic key **CHD 400** or by disabling the system with the original remote control of the vehicle.

THE FOLLOWING INSTRUCTIONS ALLOW A DEEPER KNOWLEDGE OF THE SYSTEM

PIN CARD

It is the card supplied in the box, showing the serial number of the central unit and the MAIN CODE, with the relevant use procedure. It allows the system desactivation without remote control or electronic key. It allows the electronic keys CHD 400 or the remote controls TX LW, TX PAR LW self-learning, either to add some others or to cancel the lost ones. Duplicates available on request at the installer's place giving him the "serial number" of the central unit.

EMERGENCY DESACTIVATION

On certain vehicles, the alarm can recognize the use of the original ignition key, even if the original remote control does not work or is not integrated in the key, allowing you to deactivate the system. The system can also be deactivated by entering the emergency code displayed on the **PIN-CARD** or the electronic key **CHD 400**.

USE OF THE MAIN CODE

- 1 Remove the PIN CARD label: the main code is now shown.
- 2 Insert the ignition key and turn it one time on / off to switch the LED on (red pilot light).
- 3 Before the LED is switched off, press its button down briefly as many times as the first number of the code; each time the LED switches off and 1 BIP of the buzzer (with SIR 050 / SIR 070) to confirm.
- 4 Wait until the LED is off and on again.
- 5 Repeat the 3-4 steps for each remaining code numbers.

The usual desactivation signal confirms the operation has been completed successfully.

PRESS THE BUTTON ONLY WHEN THE LED IS ON

CHD 400 ELECTRONIC KEY

They activate / deactivate the system. This in the box is ready to use.

There is antiscanner, self-learning and ROLLING CODE. It is possible to use up to 4 pieces simultaneously, cancel the lost and pair some other, new ones (please ask you installer).

SYSTEM ACTIVATION BY THE ELECTRONIC KEY

Put and press the key on its key socket (the two metallic parts have to come in contact): the LED switches on slightly "vibrating", then, once detached the key, it remains lit fixed and the buzzer gives a continuous hiss ending with the usual signaling of the system activation, after about 20 seconds.

- The procedure will cut off putting the key again on its key socket or turning the ignition key on.
- The system activates itself completely.

SYSTEM ACTIVATION BY THE ELECTRONIC KEY EXCLUDING THE ULTRASONIC SENSOR AND THE WINDOWS CLOSING

- 1) Turn the key in OFF position or open a door with [+15] OFF.
- 2) Press the LED button while it is on steady for 5 seconds.
Release the button; the LED is off now.

- 3) Press the key on its key socket. On the LED relighting press the electronic key on its key socket: the LED switches on slightly “vibrating”, then, once detached the key, it remains lit fixed and the buzzer gives a continuous hiss ending with the usual signaling of the system activation without ultrasonic sensor, windows closing and modules, after about 20 seconds.
- The procedure will cut off putting the key again on its key socket or turning the ignition key ON.

SYSTEM DESACTIVATION BY THE CHD 400 ELECTRONIC KEY:

- 1) Open the door using the original vehicle's system.
 - If it was activated using the key, it is possible to deactivate it within 8 seconds avoiding the alarm from the buttons, the ultrasonic sensor and the additional modules.
 - If the system was activated by the remote control, the system alarms.
 - If it was activated using the key, it is possible to deactivate it within 8 seconds avoiding the alarm from the buttons, the ultrasonic sensor and the additional modules.
 - When turning the ignition key on, the system alarms immediately.
- 2) Press the key on its key socket: the LED starts “vibrating” slightly, followed by the doors opening with the usual system deactivation signaling, followed by the “alarm memory”, if any alarms or anomalies have occurred.

PAIRING / CUTTING OUT OF THE CHD 400 ELECTRONIC KEYS:

- 1) With the system in off position enter the MAIN CODE as shown on the PIN CARD.
- 2) When the confirmation BEEPS end and the LED is switched on fixed again, within **8 seconds** press on the key socket for 3 close times the metallic part of each **key CHD 400 to be activated or to keep working, waiting each time the LED relighting and the BEEP from the buzzer.**

Confirmation:

- **2** Beeps close together and **2** blinks of the LED confirm that the CHD 400 has been stored.
 - **4** Beeps close together and **4** blinks of the LED indicate that this electronic key has already been enabled.
 - **6** Beeps close together and **6** blinks of the LED when the 4 electronic key foreseen are already enabled. No others can be added.
- 3) Once activated the last one, turn ON / OFF the ignition key one time or wait for 30 seconds.

WARNING:

- The unused keys during this operation **are deactivated; they can be activated again by repeating the procedure.**
- The procedure can be cut off only in the initial phase, only if the first key has been pressed for maximum 2 times. After 30 seconds without doing anything the procedure is quitted.
- Once activated the procedure, it is possible to learn the TX LW or TX PAR LW remote control.

TX LW REMOTE CONTROL

For activate / deactivate the system from distance, unlock and lock the doors, control the windows closing and the paired additional optional modules.

There is antiscanner, ROLLING CODE and self-learning.

Those in the box are ready to use. It is possible to use up to 4 pieces simultaneously, cancel the lost and pair some other, new ones (please ask your installer). To allow the internal battery to last longer, use both regularly, avoiding to let one of them unused for years.

PAIRING / CUTTING OUT OF THE TX LW REMOTE CONTROLS

- 1) With the system in off position enter the MAIN CODE as shown on the PIN CARD.
- 2) When the confirmation BEEPS end and the LED is switched on fixed again, within **30 seconds** press for **three times** consecutively one button of each remote control to be activated or to keep working, waiting each time the LED relighting and the BEEP from the buzzer.

Confirmation:





- **2** Beeps close together and **2** blinks of the LED confirm that the remote control has been saved.
- **4** Beeps close together and **4** blinks of the LED indicate that this remote control has already been enabled.
- **6** Beeps close together and **6** blinks of the LED indicate that the **4 TX LW** remote controls foreseen are already enabled. No others can be added.

3) Once activated the last one, turn ON / OFF the ignition key one time or wait for 30 seconds.

WARNING:

- The **TX LW** that are not used in this operation are disabled; **they can be re-enabled by repeating the operation.**
- The procedure can be cut off only in the initial phase, only if the button of the first remote control has been pressed for maximum 2 times.
After 30 seconds without doing anything the procedure is quitted.
- Once activated the procedure, it is possible to learn the CHD 400 electronic keys or the TX PAR LW remote control.

TX PAR LW REMOTE CONTROL unit has **4 buttons** for:

- complete activation of the system: press the button with the symbol  ;
- partial activation of just the perimeter protection MIC LW and MIC MEC LW (without volumetric sensors, or infrared sensors, or MIC LW or MIC MEC LW that can be choked), press  ;
- complete de-activation of the system: press the button with the symbol  ;
- panic function press  for 2 / 3 seconds consecutively until the alarm cycle starts.

There is antiscanner, ROLLING CODE and self-learning. Those in the box are ready to use. It is possible to use up to 4 pieces simultaneously, cancel the lost and pair some other, new ones (please ask your installer). It has a replaceable lithium battery CR 2032.

PAIRING / CUTTING OUT OF THE TX PAR LW REMOTE CONTROLS

- 1) With the system in off position enter the MAIN CODE as shown on the PIN CARD.
- 2) When the confirmation BEEPS end and the LED is switched on fixed again, within **30 seconds** press for **three times** consecutively one button of each remote control to be activated or to keep working, waiting each time the LED relighting and the BEEP from the buzzer.

Confirmation:

- **2** Beeps close together and **2** blinks of the LED confirm that the remote control has been saved.
- **4** Beeps close together and **4** blinks of the LED indicate that this remote control has already been enabled.
- **6** Beeps close together and **6** blinks of the LED indicate that the **4 TX PAR LW** remote controls foreseen are already enabled. No others can be added.

3) Once activated the last one, turn ON / OFF the ignition key one time or wait for 30 seconds.

WARNING:

- With the **TX PAR LW** you can use any one of the **4** keys available and press different keys of the same remote control for the **3 times** requested.
- The **TX PAR LW** that are not used in this operation are disabled; **they can be re-enabled by repeating the operation.**
- The procedure can be cut off only in the initial phase, only if the button of the first remote control has been pressed for maximum 2 times.
After 30 seconds without doing anything the procedure is quitted.
- Once activated the procedure, it is possible to learn the CHD 400 electronic keys or the TX LW remote control.

ALARM FUNCTIONS

When the system is activated the alarm is given / signalled by the siren, the direction indicators, the LED and the additional warning horns.

Cycles of about 25 seconds, with cut off by the remote control or the emergency procedure.

DOORS, BONNET, BOOT OPENING

Detected by analogue instantaneous input (LIGHT BLUE wire):

- Instantaneous on the system activation.
- The alarm is not repeated if the door is left open.
You can set just 3 (max. 10) alarm cycles instead of the 1 standard cycle, with the door open.
- The alarm is repeated only if the door is closed and opened again after the current cycle is terminated.
- Unlimited alarm cycles.

DOORS, BONNET, BOOT OPENING AND ADDITIONAL MODULES

Detected by analogue delayed input (LIGHT BLUE / WHITE wire):

- Delayed by 30 or 50 seconds on activation (standard times), then instantaneous.
- The alarm is not repeated if the door is left open.
You can set just 3 (max. 10) alarm cycles instead of the 1 standard cycle, with the door open.
- The alarm is repeated only if the door is closed and opened again after the current cycle is terminated.
- Unlimited alarm cycles.

DOORS, BONNET, BOOT OPENING

Detected by means of the original data transmission line of the vehicle: "CAN":

- Instantaneous on the system activation.
- The alarm is not repeated if the door is left open.
You can set just 3 (max. 10) alarm cycles instead of the 1 standard cycle, with the door open.
- The alarm is repeated only if the door is closed and opened again after the current cycle is terminated.
- Unlimited alarm cycles.

IGNITION KEY (for at least 2 seconds)

- The starting attempt causes an alarm cycle.
- The alarm is not repeated if the key is in the ON position (instrument panel lit).
- The alarm is repeated only if the key is turned back in the OFF position and then let in the ON position for at least 2 seconds.
- Unlimited alarm cycles.

OPENING OF DOORS, HATCH DOORS, BONNET OR BOOT

Detected by wireless sensors of series: MIC LW, MIC MEC LW:

- Instantaneous on the system activation: opening the door, the windows, storage compartment, etc.
- If, when the system is activated, the door, bonnet, windows, storage compartment, etc. is / are already open, the sensor does not send the alarm.
To activate the alarm it / they must be closed and opened again.
- The alarm cycle is not repeated if the door, the windows, storage compartment, etc. is left open.
- The alarm is repeated only if the door is closed and opened again after the current cycle is terminated.
- Unlimited alarm cycles.

ULTRASONIC SENSOR

- The alarm cycle is repeated with a break of 5 seconds, if the alarm cause persists continuously.
- The blinding / masking of the sensors, if detected on the system activation, causes some warning signalings (LED, direction indicators, siren), followed by an alarm cycle.
- As long as the system is activated a maximum of 10 alarm cycles is possible from the ULTRASONIC sensor.

INTRUSION FROM INFRARED SENSOR

Detected by wireless sensors of the series: **SEN INFRA LW, SEN INFRA 360 LW:**

- There must be a lapse of 2 / 3 minutes between 2 subsequent detections, therefore if you get out of the vehicle and the system activates immediately, the sensor will only be operational at the end of the 2 / 3 minutes.
- The alarm is only repeated after the set 2 / 3 minutes if there is another intrusion or if the person in the vehicle makes other movements.
- For the whole time the system is activated, 10 overall alarm cycles at the most are possible among all the wireless sensors: SEN INFRA and MIC LW, MIC MEC LW choked.

DETECTS SOPORIFIC GAS or LPG: Detected by wireless sensors: **SEN GAS LW**

- 1 alarm cycle if the ignition key [+15] OFF even if it is de-activated, providing it is not in the OUT OF ORDER status.
- The alarm / warning control is made directly, by the internal buzzer.
- To re-activate it, the module must be switched OFF and ON again using its switch.

WARNING:

- If an alarm occurs during another one, this last one will be not considered.

ULTRASONIC SENSOR

The internal microprocessor monitors the vehicle continuously, constantly adapting its working parameters to the environment where it is installed to better understand and identify the real alarms from false signalings. The **ANTI-TAMPERING** (anti-masking and anti-blinding) function constantly controls the efficiency of the sensors and of their wirings, warning in case of any attempts. On its activation it checks its correct working conditions and its own parameters in full, then it start the vehicle surveillance (flashing LED). The anomalies, if any, are signalled by the siren and by the direction indicators flashing for some seconds, followed by an alarm cycle and by 5 BEEPS subsequent to the desactivation of the system.

ADDITIONAL MODULES

It is possible to integrate the central unit with some optional sensors to signalise, when the system is active, the vehicle lifting, the shock, and all type of intrusion by the infrared or the hyperfrequency (proximity sensor).

This last sensor is particularly indicated for the spider and the coupe vehicles, to protect the cockpit when the windows and / or the roof are open or, combined with the traditional ultrasonic sensor, for big size vehicles or to protect a second space like with vans.

LOW BATTERY

If the vehicle's battery slowly gets down (due to some lamps or other devices left on), the siren desactivates itself without causing any alarms.

Charge the vehicle battery again following the specific instructions, then desactivate the system by the remote control, the electronic key or the emergency code.

REDUCTION OF THE CURRENT CONSUMPTION

To reduce at the maximum the current consumptions and protect the vehicle's battery life, the central unit cuts the ultrasonic sensor out and the warning LED after 8 "on duty" days.

PROGRAMMINGS

It is possible to customize the system using the USER'S programming instructions or by pairing it with the original system using the INSTALLER'S one.

WARNING: Acoustic signals are only featured with the sirens **SIR 050** or **SIR 070 LW**.

To enter into the PROGRAMMING mode:

1 With the doors, bonnet and boot closed, switch the panel key **ON** and **OFF once**, in order to turn on the LED for 2 seconds.

2 Before the LED is switched off, press its button to:

11 times consecutively (**USER'S programming**).

Confirmation: The buzzer will emit a brief BEEP whenever pressed, emitting a different tone at the **11th** press, followed by the LED blinking briefly **11 times**, with **11 BEEPS** of the buzzer.

When the LED lit fixed, we are in the programming phase.

12 times (**INSTALLER'S programming**).

- **12 times** consecutively - for pairing with the vehicle - part one.

- **13 times** consecutively - for pairing with the vehicle - part two.

- **14 times** consecutively - for wireless sensors LW.

Confirmation: The buzzer will emit a brief BEEP whenever pressed, emitting a different tone at the **11th** or **12th / 13th / 14th** press, followed by the LED blinking briefly **12 / 13 / 14 times**, with **12 / 13 / 14 BEEPS** of the buzzer.

When the LED lit fixed, we are in the programming phase.

WARNING:

- Pressing the LED button only the BEEP of the buzzer confirms the signal has been recognized by the central unit.

- Further confirmation is given by the number of times the LED blinks and the buzzer BEEPS, which is the same as the number of times the button was pressed previously.

- If the LED goes off automatically within 2 or 3 seconds, or you notice brief and close blinking of the LED and buzzer BEEPS, wait 30 seconds and repeat the procedure from point 1.

An unforeseen programming was performed or you have quit a programming sequence.

3 With the LED lit fixed press its button as many times as the chosen programming (stated in the following tables).

- On every valid pulse the LED switches off temporarily and the buzzer gives 1 BEEP.

4 At the end of the sequence, the system will signal that it has accepted the programmed settings with by the LED **blinking** and the buzzer **BEEPING** by the number of times the button was pressed; followed by a two-tone signal, a few LED flashes and BEEPS of the buzzer, will follow and then the LED will again be on steady.

- If the LED switches off autonomously within 2 / 3 seconds or short BEEPS and very quick flashings of the LED indicate a denial: the made programming does not exist.

Wait for 30 seconds and repeat the procedure again from point 1.

5 Terminate the procedure turning the ignition key **ON / OFF** one time.

WARNING:

● The procedure can be started only if the system is deactivated.

● Once entered into the programming mode it is possible to set up in succession more functions belonging to the same category.

● The completed and confirmed programmings remain active also when the central unit is not feed.

● By a personal PC (or laptop) paired to a programming kit, **KIT SK PLUS** the installer can choose and carry out in a simple and quick way the programmings stated in the table. Use the **SOFTWARE MED PLUS 1.0** version or one successive. You can also check programmed settings, enter other settings reserved to the PC, update the control unit operation program.

He can also program the central unit with the suitable interface program.

DIRECTION INDICATORS'S FLASHING ACTIVATION / DESACTIVATION
3 Activation / Cutting out - standard setting
ACOUSTIC SIGNALINGS ACTIVATION / DESACTIVATION
4 Cutting out / Activation - standard setting
OUT OF ORDER
5 Out of order / On duty - standard setting
ALARM CYCLES NUMBER FROM BUTTONS INPUTS
6 3 alarm cycles / 1 alarm cycle - standard setting
CAN BUTTONS INPUT CUT OFF / ACTIVATION
7 Cutting out / Activation - standard setting
INSTANTANEOUS BUTTON INPUTS CUT OFF / ACTIVATION
8 Cutting out / Activation - standard setting

The central unit works even without the a.m. programmings.

DIRECTION INDICATORS FLASHING ON THE SYSTEM ACTIVATION / DESACTIVATION

If the opening / closing doors are not signalled by the direction indicators, quite often it's possible to activate this function by the control unit.

ACOUSTIC SIGNALINGS ON ACTIVATION / DESACTIVATION

It is possible to cut them out by using the programming keeping the service signalings working (for example the alarm memory, **only with SIR 050 or SIR 070.LW**).

OUT OF ORDER OF THE SYSTEM

Suggested in case the vehicle has to stay in the repair shop, garage, or when the vehicle does not need to be protected.

When OUT OF ORDER, the system cannot be activated and any attempt gives 5 BEEPS and 5 LED flashings. It cuts out all the central unit functions.

Repeat the programming to activate the system completely again.

CYCLES NUMBER FROM THE BUTTONS INPUTS

It allows 3 alarm cycles of the buttons and of the additional modules (instead of a single cycle) throughout the alarm condition and every time the alarm condition occurs.

Select number of the cycles from 1 to 9 only with PC.

See ALARM FUNCTIONS.

BUTTONS INPUT DESACTIVATING

It is used to disable the detection function of the door, bonnet, boot buttons and supplementary modules separately for the analogue input Light Blue wire or the other analogue input Light Blue/White wires or detected by the CAN line, leaving the other protection systems activated: other analogue input, CAN line, starting, volumetric radar sensor, wireless sensors.

WARNING:

Use the procedure just in case of a button or sensors failure when the car is by a repair shop.

INSTALLER SECTION

PAIRING WITH THE VEHICLE AND WITH THE INSTALLED ACCESSORIES

WARNING: Every change in these parameters can
Compromise the correct working of the system

PROGRAMMINGS FOR THE INSTALLER - PART ONE

(12 TIMES)

DIRECTION INDICATORS'S FLASHING ACTIVATION / DESACTIVATION	
3	Activation / Cutting out - standard setting
DIRECTION INDICATORS CONTROL	
4	With 2 wires by relays separated channels (right / left side separated) - "USUAL CONNECTION"
5	Single negative control with starting and final blinking IMPULSE - standard setting
6	Single negative CONTINUOUS control
ALARM ACTIVATION ON DOORS CLOSING	
7	Activation / Cutting out - standard setting
PRE-ALARM	
8	Activation / Cutting out - standard setting
ALARM OUTPUT (BROWN wire - OUT 3)	
9	Intermittent / Fixed - standard setting
DELAYED TIME ON ACTIVATION BUTTONS (Light BLUE/WHITE wire - IN 1)	
10	Istantaneous (0 second)
11	30 seconds - standard setting
12	50 seconds
FIXED / TIMED STATUS SIGNAL (GREY wire - OUT 4)	
13	Timed (10 seconds standard, cutting out) / Fixed - standard setting
FIXED / ADDITIONAL MODULES CUTTING OUT (GREY wire - OUT 4)	
14	Cutting out (along with the temporary cutout of the radar sensor - only with status signal FIXED) / Fixed - standard setting
TIME OF THE STATUS SIGNAL (IF TIMED - GREY wire - OUT 4)	
15	10 seconds, cutting out - standard setting
16	30 seconds, cutting out
17	50 seconds, cutting out
ANTI-TAMPERING OF THE ULTRASONIC SENSOR	
18	Cutting out / Activation - standard setting
ULTRASONIC SENSOR	
19	Cutting out / Activation - standard setting
ULTRASONIC SENSOR SENSITIVITY	
20	Low
21	Medium - standard setting
22	High
READ [+15] BY CAN LINE (only preset vehicles)	
23	Cutting out / Activation - standard setting
SUPPRESSOR ON BUTTONS INPUT DELAYED (Light BLUE/WHITE wire - IN 1)	
24	Long / Short - standard setting
RESET OF THE INITIAL CONDITIONS PROGRAMMED AT DEFAULT	
30	Standard values setting

The central unit works even without the a.m. programmings.

DIRECTION INDICATORS FLASHING ON THE SYSTEM ACTIVATION / DESACTIVATION

The control unit can pilot the direction indicators both during an alarm and when switching the system on / off, if the vehicle does not already feature its own door opening / closing signals, or if the remote controls and the electronic keys CHD 400 are used in different modes, depending on the original equipment.

Also refer to the assembly instructions and as "user programming".

ALARM ACTIVATION ON DOORS CLOSING

It's possible to be activated only with the instantaneous buttons input (Light BLUE wire - IN2) or with the buttons detected by the original data transmission "CAN" (also refer to the assembly instructions).

By pressing the locking button of the original remote control with an open door, the system signals the denial on activation giving 3 BEEPS and 3 LED flashings followed by a continuous hiss from the buzzer.

Only the door closing stops the signal and activates the alarm system, even if the door is not locked.

On some vehicles with separate button for opening the boot allows you to manage the system's automatic re-closing of the boot.

Without this feature, after the closing of the door you have to repeat the input of the system.

PRE-ALARM

Needed to avoid short unwanted alarms with vehicles where the alarm system deactivation in security requires some seconds, to complete all the necessary checks. When activating this function, all the intrusion as well as doors, bonnet and boot opening alarms are preceded by a hiss from the buzzer. If the system is not correctly deactivated within 5 / 8 seconds, the normal alarm signaling is activated.

ALARM OUTPUT (BROWN wire - OUT 3)

It has to be kept fix in case of an electronic siren or if it's paired to the satellite protection, otherwise intermittent only if it's used to control the vehicle klaxon.

INSTANTANEOUS / DELAIED BUTTONS INPUT (Light BLUE/WHITE wire - IN 1)

On the system activation the input can be instantaneous or delayed (**30** or **50 seconds** then it becomes instantaneous). Standard times, vary more widely from PC.

It must be delayed when the signal is taken by the delayed switching off internal roof lamp or if are used the additional modules (anti lifting, high frequency, etc).

The set up depends on the vehicle model and on the paired accessories.

FIXED / CUTTING OUT / TIMED STATUS SIGNAL OUTPUT (GREY wire - OUT 4)

- **FIXED:** To enable a sensor which is always active with the system engaged.
- **CUTTING OUT:** To not enable an additional sensor if the windows are opened or there is person or animal on board.
- **TIMED:** With vehicles having a "comfort" equipment (simultaneous windows closing by turning the original key in the door lock block), it is possible "to automate" the windows closing on the system activation using the status output as timed, according to the vehicle's features.

If the output is set to CUTTING OUT or TIMED, by engaging the system with the temporary cutout of the radar sensor and the additional modules, the output will not be available.

NOT ENABLED RECOGNITION [+15] BY CAN

Avoids reading of [+15] ON (panel key signal on, engine running) by the original "CAN" line of the vehicle. The analogical line will be permanently ON (ORANGE wire).

SUPPRESSOR ON BUTTONS INPUT DELAYED (Light BLUE/WHITE wire - IN 1)

The long filter is used only on vehicles without CAN line, and send them to your ceiling a short negative pulse several minutes after the close of the vehicle (eg, some cars FIAT - LANCIA can send it after 20 / 40 minutes). Only for Light BLUE/WHITE wire .

RESETTING OF THE INITIAL CONDITIONS PROGRAMMED AT DEFAULT

It allows to restore the original condition of the central unit, resetting all the default programmings, keeping active med sensors, remote controls and keys combined.

PROGRAMMINGS FOR THE INSTALLER - PART TWO (13 TIMES)

CENTRAL DOORS LOCKING / NEGATIVE OUTPUT POSSIBLE TO BE CUT OUT (GREY/BLACK wire - OUT 1)	
4	Negative output possible to be cut out / Central doors locking - standard setting
SETTING OF THE DOORS LOCKING/UNLOCKING TIME	
5	0,8 seconds locking / unlocking - standard setting
6	3 seconds locking / unlocking
7	10 seconds locking / 0,8 seconds at unlocking
8	30 seconds locking / 0,8 seconds at unlocking
DOORS LOCKING ACTIVATION / TIMED STATUS (GREY wire - OUT 4)	
9	Simultaneous / Delayed - standard setting
DOUBLE CONTROL FOR DOORS LOCKING (GREY/BLACK wire - OUT 1)	
10	Activation / Cutting out - standard setting
AUTOMATIC ACTIVATION OF THE ENGINE LOCK	
15	Activation / Cutting out - standard setting
WAY TO ACTIVATE THE AUTOMATIC ENGINE LOCK	
16	Immediate / Delayed to 5 minutes - standard setting
STARTING ENGINE EXCLUSIVELY USING THE CHD 400 ELECTRONIC KEY	
17	Activation / Cutting out - standard setting
MED 30.x DIGITAL IMMOBILIZER (on MUX line - PURPLE wire)	
25	Replacement of the alarm central unit paired with the immobilizer of the MED 30 series

The central unit works even without the a.m. programmings.

CENTRAL DOORS LOCKING / NEGATIVE OUTPUT POSSIBLE TO BE CUT OUT

(GREY/BLACK wire - OUT 1)

If they are used med remotes control, the central can often drive the door opening / closing (either directly or via the additional module **KIT AP / CH** cod. **674980000** - vehicles designed), otherwise the output can drive additional modules can be disabled with the radar sensor .

DOORS LOCKING / UNLOCKING TIME - COMFORT

The standard preset times to locking / unlocking doors are **0,8 seconds**.

With vehicles having a "comfort" equipment (simultaneous windows closing by turning the original key in the door lock block), it is possible "to automate" the windows closing on the system activation delaying the doors locking time or using the status output as timed, according to the vehicle's features.

If necessary, it is possible to let the controls of the doors locking and of the windows closing be simultaneous, and to preset the opening / closing times at 3 seconds (for example, vehicles equipped with pneumatic system like MERCEDES W 124 - W 129 series).

With vehicles equipped with security lock activated by the **double control** on the doors locking wire, this function can generally be activated.

AUTOMATIC ACTIVATION OF THE ENGINE LOCK

The **ECE / ONU Regulation no. 97** states that the immobilizers have to get ON automatically even if the system is not activated by the remote control or the electronic key.

The automatic activation can be:

- **Immediate on a door opening**, if it follows the turning off of the ignition key, or with a 1 minute delay if there is already an open door (please note that some vehicles consider the door “open” till the “locking” of its door lock block).
3 short signals of the buzzer, 3 flashings of the LED indicate the activation of the engine lock.
- Trying a starting **[+15] ON**, the engine does not work, the direction indicators and the LED is lit fixed.
- Trying a starting **[+15] ON** again, the engine does not work, flashings the direction indicators. 1 alarm cycle if the key is in the **ON** position **[+15] ON** for at least 2 seconds;
Block the alarm cycle turning **[+15] OFF** the ignition key.

Desactivate the system using the remote control the electronic key or the emergency code.

- **With a 5 minute delay** from the engine stop (ignition key **OFF**):
3 short signals of the buzzer, 3 flashings of the LED indicate the activation of the engine lock.
- A door opening makes 3 short signals of the buzzer, 3 flashings of the LED (maximum 5 times consecutively).
- Trying a starting **[+15] ON**, the engine does not work, the direction indicators and the LED is lit fixed.
- Trying a starting **[+15] ON** again, the engine does not work, flashings the direction indicators. 1 alarm cycle if the key is in the **ON** position **[+15] ON** for at least 2 seconds.
Block the alarm cycle turning **[+15] OFF** the ignition key.

Desactivate the system using the remote control the electronic key or the emergency code.

WARNING: With the automatic engine lock activation:

- If you have not made an attempt to start, generally the use of the remote control activates the system in a comprehensive manner. Verify that the system is actually inserted.
- If you have made an attempt to start:
 - the use of med TX LW or TX PAR LW can turn off the system normally.
 - with the original remote control operation depends on the vehicle; generally need to close and open again the doors, turn off the system and start the engine.

STARTING ENGINE EXCLUSIVELY USING THE CHD 400 ELECTRONIC KEY

Is possible to differentiate the system is disarmed, or let the original or the med remote control open the doors and turn off the alarm, but does not turn the engine-block.

- Attempting to start the engine, does not start and the alarm (siren) sounds continuously.
- Repeating the start **[+15] ON**, the engine will not start and flashing arrows; when the ignition is turned on, the alarm is activated 1 cycle, which is interrupted by turning off the ignition key **[+15] OFF**.

Desactivate the system using the electronic key or the emergency code, and start engine.

DIGITAL IMMOBILIZER - CENTRAL UNIT REPLACEMENT

The installation or the replacement of the immobilizers on the MUX line (for example, **MED 30.x** series) don't need any pairing with the central unit. Also the replacement of the central unit made within the first 20 startings doesn't require any specific operation.

But after **21 startings** **[+15] ON / OFF** with the same central unit, the engine lock accepts only that code (different for each central unit) of the central unit.

To keep the same immobilizer replacing only the central unit it is necessary:

- 1 To have the MAIN or PERSONAL emergency code of the old alarm central unit installed.
- 2 To install the new alarm central unit, with “MUX” exit.
- 3 To enter into the installer programming “alarm central unit replacement”: (13 + 25), pag. 13.
After 10 seconds of quick LED flashings and BEEPS from the buzzer, the LED flashes slowly:
14 skip to point 4.

- 4 Turn [+15] ON / OFF the ignition key one time. With the LED lit fixed, enter the MAIN code of the OLD central unit. At the end the LED is lit fixed.
- 5 Disconnect the feeding of the central unit for at least 1 minute.
- 6 Feed the system (acousting confirmation, followed by a system desactivation signalling); then test the equipment.
 - If the engine doesn't start or it stops after a few seconds, repeat the procedure from point n.3.
 - If the engine stays regularly ON, the procedure has been followed correctly and the immobilizer, after 20 startings made with the same new central unit, will be paired with it definitively.

WIRELESS SENSORS PROGRAMMINGS (14 TIMES)

SIR 070 LW - WIRELESS SIREN 3 Activation / Cutting out - standard setting
PAIRING WIRELESS SENSORS: MIC LW, MIC MEC LW, SEN INFRA LW, SEN GAS LW, SIR 070 LW 5 It adds new sensors.
FORCED PAIRING OF CHOKED WIRELESS SENSORS 7 It adds new sensors of series MIC LW and MIC MEC LW as choked sensors.
TESTING WIRELESS SENSORS MIC LW, MIC MEC LW, SEN INFRA LW, SEN GAS LW 12 It activates the operational test for all the sensors of series.
ELIMINATING LW WIRELESS SENSORS 20 It deletes all the paired sensors of series: MIC LW, MIC MEC LW, SEN INFRA LW, SEN GAS LW
ELIMINATING ALL LW WIRELESS: SENSORS AND MODULES 30 It deletes all the paired sensors of series: MIC LW, MIC MEC LW, SEN INFRA LW, SEN GAS LW, SIR 070.LW SIREN, TX LW and TX PAR LW REMOTE CONTROL

The wireless sensors and the remote controls supplied in the pack are already paired with their control unit.

SIR 070 LW - WIRELESS SIREN

The siren supplied in the pack is ready to use. If supplied separately, or only for replacing, to be able to match the alarm unit must first be activated via PC or by manually programming (button of the LED pressed **14 + 3 times**). When this is finished, programme as follows.

PAIRING WIRELESS SENSORS:

MIC LW, MIC MEC LW, SEN INFRA LW, SEN GAS LW and **SIR 070 LW**

The procedure is used to manage the wireless sensors of series MIC LW and MIC MEC LW, which are always enabled when the system is activated, up to a maximum number of :

- **30** MIC LW and MIC MEC LW standard (always activated whit the system is activation);
- **10** MIC LW, MIC MEC LW as choked sensors, with 2 SEN INFRA LW infrared sensors;
- **3** SEN GAS LW gas sensors;
- **1** SIR 070 LW electronic siren.

You are recommended to carry out the procedure on a workbench, or in any event near the alarm control unit before fitting the sensors on the vehicle, making sure to install the power supply batteries in them beforehand.

The central unit is powered, the **LED / BUTTON** and the siren must be connected and activated.



The battery-holder supports can only be fitted in the MIC LW and MIC MEC LW if they are already complete with the battery CR 2032, otherwise it will be impossible to take them out again.

1) Once in programming mode (button of the LED pressed **14 + 5 times**) according to the procedure just described, which is confirmed by the signals indicated, the LED is now lit steady.

2) You can now add new sensors as follows:

MIC LW = Rest the magnet for **2 seconds** and move it away from the arrow over the MED mark, until confirmation is given **3 times** consecutively.

MIC MEC LW = Press the built-in button of the sensor for **2 seconds** and release it, until confirmation is given **3 times** consecutively.

SEN INFRA LW = The infrared sensors are supplied in TEST mode, therefore after pairing them and testing them on the vehicle, they have to be set in standard service mode, following the instructions below.

Pass in front of the sensor until its LED switches on and the control unit provides confirmation **3 times** consecutively, or simply open and close the casing, again **3 times** consecutively (the anti-sabotage button trips).

SEN GAS LW = Press the push button behind the **SEN GAS LW** sensor **3 times** consecutively (hold down for **2 seconds** and release for 2 seconds).

Each time it is earthed the buzzer inside the sensor emits 1 sound. At the end, isolate the WHITE wire if not used or connect it to the actuator wanted.

SIR 070 LW = Press the button of the bonnet connected to SIR 070.LW **3 times** consecutively (2 seconds pressed, 2 seconds released) or connect the BLUE/WHITE wire of the siren to ground **3 times** consecutively (2 seconds connected, 2 seconds disconnected).

Confirmation:

- **2 Beeps** close together and **2 blinks** of the LED confirm that the sensor has been stored.
- **4 Beeps** close together and **4 blinks** of the LED indicate that this sensor has already been enabled.
- **6 Beeps** close together and **6 blinks** of the LED when all sensors envisaged have already been enabled.

To add others, delete those already paired via the specific program and teach-in just those really in use again.

3) End the procedure, switch the ignition key **[+15] ON** and **OFF** once.

WARNING:

- Perform the teach-in procedure slowly and always make sure the confirmation signals are given:
 - **1 Beep**, LED **OFF** and **ON** after each transmission;
 - **2, 4 or 6 Beeps** and **blinks** of the LED after the **3** sequential transmissions for each sensor. Without the final indication (2, 4 and 6 beeps), after 5 seconds, repeat the saving procedure again.
- Once in programming mode, or between the pairing procedures of 2 different sensors, no more than **2 minutes** must lapse, otherwise exit and access the procedure again to complete the pairing procedure.
- The paired sensors remain stored even if the control unit is not powered until they are deleted via the specific program.
- The infrared sensors are recognised by the system and are always managed as choked sensors.
- The gas sensors are managed as always active, also when the system is not armed (engine switched off).
- Only one **SIR 070 LW** can be paired to the system. If a second one is paired it excludes the first.
- For programming and self-learning of the LW sensors is good that there is a SIR 050 or SIR 070 LW already matched, otherwise we will not have the beeps for confirmation; LED / button must therefore always be fully depressed briefly, checking the indications in the LED / button.

FORCED PAIRING OF WIRELESS SENSORS AS CHOKED

The procedure is used to manage a part of the sensors of series MIC LW and MIC MEC LW as choked, or rather that can be excluded together with the radar and infrared sensors, up to a maximum of 10, including infrared sensors of series SEN INFRA LW.

Following the instructions, the procedures and the warnings given for the teach-in function of the wireless sensors explained earlier, with the only difference being that of accessing the programming function by pressing the button of LED **14 + 7** times to force them as “choked”.

WARNING:



- If the same sensor MIC LW or MIC MEC LW is enabled as both standard and choked, the control unit will consider it to be “choked”.
- When a sensor MIC LW or MIC MEC LW is saved as choked, if you want to reset it as a standard sensor, you have to delete all of them and teach them in again.

TESTING WIRELESS SENSORS

The procedure is used to quickly test the correct transmission of the wireless sensors, to check which group they belong to and which of them sent the last alarm signal.

- 1) Program by pressing the button of the LED **14 + 12** times.
- 2) After the confirmation signal is given, while the LED is lit steady, activate all the sensors to be tested individually; for each activation, the buzzer and the LED will provide the following indications:
 - 1 Beep and 1 blink = standard wireless sensor;
 - 2 Beeps and 2 blinks close together = choked wireless sensor and SEN INFRA LW;
 - 5 Beeps and 5 blinks close together = wireless sensor that sent the last alarm.
- 3) Turn the ignition key **[+15] ON** and **OFF** once to end the TEST.

WARNING:

- The test can be carried out as many times as you like.
- During the test phase, you can interrogate the same sensor a number of times; the indication does not change.
- If you exit test mode or the power supply is disconnected from the control unit, the indication of the last wireless sensor that sent the alarm is deleted.
- The indication of the last wireless sensor that generated the alarm is not affected by other alarm causes: ignition key, radar sensor, buttons of doors detected by the light blue/white wire or by the CAN line, therefore the last alarm encountered may not depend on these sensors.
- During the test phase, if nothing is done for 3 / 4 minutes, the test exits automatically.
Turn the ignition key **[+15] ON** and **OFF** once all the same.

DELETING ONLY LW WIRELESS SENSORS

It deletes the paired sensors of series: **MIC LW, MIC MEC LW, SEN INFRA LW, SEN GAS LW.**

- 1) Program by pressing the button of the LED **14 + 20** times.
- 2) After the confirmation signal is given, when the LED is lit steady, turn the ignition key **[+15] ON** and **OFF** once.

The LW wireless sensors are now deleted.

The SIR 070 LW siren, the TX LW and TX PAR LW remote control, if present, is active.



WARNING: Repeat the pairing procedure for all the sensors in use.



DELETING ALL LW WIRELESS SENSORS:

SIR 070 LW SIREN, TX LW and TX PAR LW REMOTE CONTROL

It deletes all the paired sensors of series:

MIC LW, MIC MEC LW, SEN INFRA LW, SEN GAS LW,
and the **SIR 070 LW SIREN, TX LW and TX PAR LW REMOTE CONTROL**

- 1) Program by pressing the button of the LED **14 + 30 times**.
- 2) After the confirmation signal is given, when the LED is lit steady, turn the ignition key **[+15] ON and OFF** once.

The LW wireless sensors and SIR 070 LW, TX LW / TX PAR LW are now deleted.



WARNING: Repeat the pairing procedure for all the sensors in use, the SIR 070 LW TX LW / TX PAR LW, with your specific programming.



MAINTENANCE The central unit does not need any maintenance.

The sensors MIC LW, MIC MEC LW and infrared sensors have to be installed inside the vehicle, protected against the infiltration of liquids and condensate and away from heat sources.

The lens of the infrared sensors must not be knocked.

The sensors can be cleaned using a dry cloth. Do not use solvents or paint thinners

The sensors MIC LW, MIC MEC LW, SEN INFRA LW, SEN INFRA 360 LW and the TX PAR LW have an indicator LED to check the efficiency of the internal battery.

When the battery runs low, it can be replaced with the following types of batteries:

- MIC LW, MIC MEC LW and TX PAR LW **3V lithium** batteries, type **CR 2032**
- SEN INFRA LW and SEN INFRA 360 LW **3V lithium** batteries, type **CR 123 A**



When replacing the battery, do not touch the circuit or the battery with wet hands.

Do not attempt to charge dead batteries. Do not throw on the fire. Do not swallow.

Dead batteries are to be disposed of in dedicated waste battery containers according to laws currently in force in the individual countries.

Strictly keep the sensors and the batteries out of children's reach.

WARNING:



- The **BATTERY HOLDER** can only be fitted in the MIC LW or MIC MEC LW with the battery CR 2032 actually inserted, otherwise it will be impossible to take it out again.

- When washing the engine, protect the electronic siren adequately.

DISCHARGED BATTERY SIGNALIZINGS FROM:

MIC LW, MIC MEC LW, TX PAR LW, SEN INFRA LW

TX PAR LW pressing one of the four buttons of the remote control:

- **1 LED blinking** = internal battery working;
- **2 closed LED blinking** = the battery is quite low: replace it as soon as possible.

MIC LW and **MIC MEC LW** opening the window, the door or the hatch doors:

- **1 LED blinking** = internal battery working;
- **2 closed LED blinking** = the battery is quite low : replace it as soon as possible.

SEN INFRA LW / SEN INFRA 360 LW passing the sensor after at least two minutes that none passed (with the LED active; if it is deactivated the only possible test is to trigger the alarm):

- **LED blinking** = internal battery working;
- **Any blinking** = low battery: replace it.

WARNING:

- The high / low temperature, humidity or the sporadic use can interfere with the correct low battery signaling.

WARRANTY CONDITIONS

The technical warranty has a duration of 24 months from the date of installation, ex-works, and covers those parts considered as defective only by A.E.B. S.p.A.

Any other external labor or extra costs are excluded.

HOMOLOGATIONS

The **MED 11.5** central unit is type-approved as an ALARM system according to **Regulation ECE / ONU no. R 97** with the number: **(E3) 97R A-01 6002**

The **ECE / ONU Regulation no. 97**, referring to functioning and safety of alarm systems is equivalent to the European Directive 95/56/EC and is also recognised in non EEC countries such as, for example, Russia, Japan, etc.

This regulation includes immunity to interference tests and the EMC tests in accordance with the **ECE / ONU Regulation no. 10**.

The **MED 11.5** central unit is type-approved as an ALARM system according to **Regulation ECE / ONU no. R 10** with the number: **(E3) 10R-04 6459**

Type approval also includes the **TX 4000 LW** and **TX PAR LW** remote control, the **CHD 400** electronic keythe wireless sensors of series **MIC LW**, **MIC MEC LW**, **SEN INFRA LW** and **SEN INFRA 360 LW**.

The electronics siren **SIR 050** and the wireless siren **SIR 070.LW** are type-approved concerning the electromagnetic compatibility (interferences and noises) according to **Regulation ECE / ONU no. R 10**, and is also recognised in non EEC countries such as, for example, Russia, Japan, etc. with the number: **(E3) 10R-03 6414**

WARNING:

The **MED 11.5** central units are projected and set according to the product technical brochure specifications indicated in the compliance statement and in the working instructions.

Any product tampering or any changement in the a.m. features as well as any intervention in the working way or in the connection done without complying with the installing instructions can modify these conditions according which the product is homologated to, which can have consequences on the further product selling.

DECLARATION OF CONFORMITY



Standard of reference ISO/IEC Guide 22 and EN 45014

Number of conformity: **010-2013/E**

Name of the manufacturer: **A.E.B. S.p.A, antitheft division**
Address: **via dell'Industria, 20**
Corte Tegge
42025 Cavriago (RE) Italy

HEREBY STATES THAT THE ELECTRONIC UNIT

Name of the product: Alarm system **MED 11.X**

IS IN COMPLIANCE WITH THE FOLLOWING PRODUCT SPECIFICATIONS:

FIELD	Directive	Requirements	Standards applied	References	Test Result
R&TTE	99/5/CE	Human exposure to electromagnetic fields (art. 3.1a):	EN 62479:2010	Official Journal of the European Union L 91 del 7/4/1999	applied
		Safety (art. 3.1a):	Test rilevanti menzionati nel Regolamento ECE R97 Rev.1 EN 60950-1:2006 + A11:2009 + A1:2010 + A12:2011 + AC:2011		applied
		EMC (art. 3.1b):	Regolamento ECE R97, Allegato IX		applied
		Radio spectrum (art. 3.2)	EN 301 489-1 V1.9.2 EN 301 489-3 V1.4.1 EN 300 220-1 V2.4.1 EN 300 220-2 V2.4.1 EN 300 328 V1.7.1 (2006-10)		applied

THEREFORE IT IS IN COMPLIANCE WITH THE REQUIREMENTS OF THE CE MARKING

The equipment was checked in a typical working configuration

THE PRODUCT IS MARKED WITH CE MARK AND NOTIFIED NUMBER ACCORDING TO THE DIRECTIVE 1999/5/CE



Place of issue: **Cavriago (RE) Italy**

Date of issue: **02/12/2013**

CEO of **A.E.B. S.p.A.**
Fiaccadori Antonia

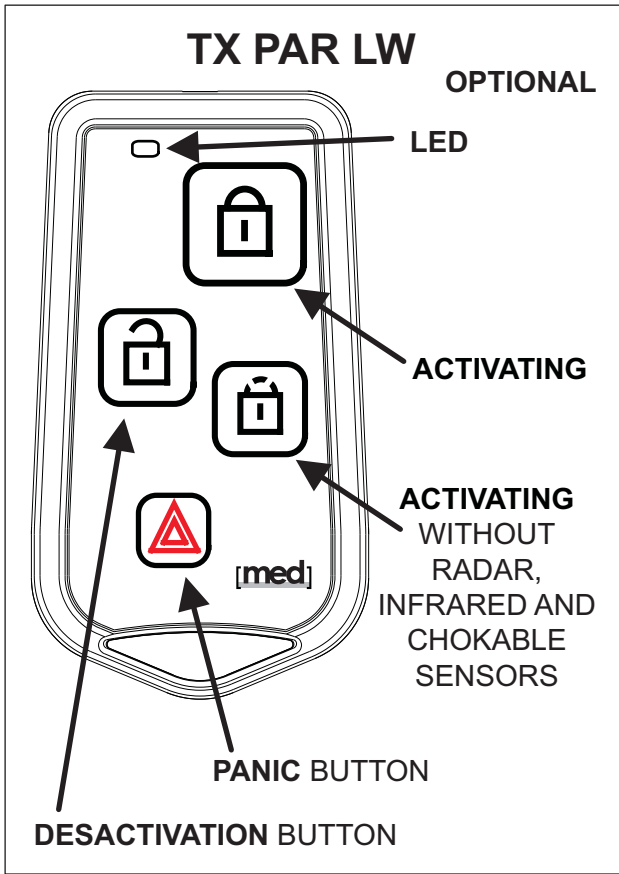

TX 4000 LW OPTIONAL

BUTTON

COMPLETE ACTIVATING of the system
Press the button **once** the button of the remote control.

DESACTIVATION
Press the button **once** or **2 times** in fast sequence (only for those cars where the double manual control opens the driver's door first, and then the passengers' ones).

ACTIVATING WITHOUT RADAR, INFRARED AND CHOKABLE SENSORS
Press in quick succession the button **twice**.

SEN GAS LW OPTIONAL

LED

BUZZER

ON

SEN GAS LW

SENSOR

OPTIONAL

BUTTON ON / OFF

BATTERY REPLACED

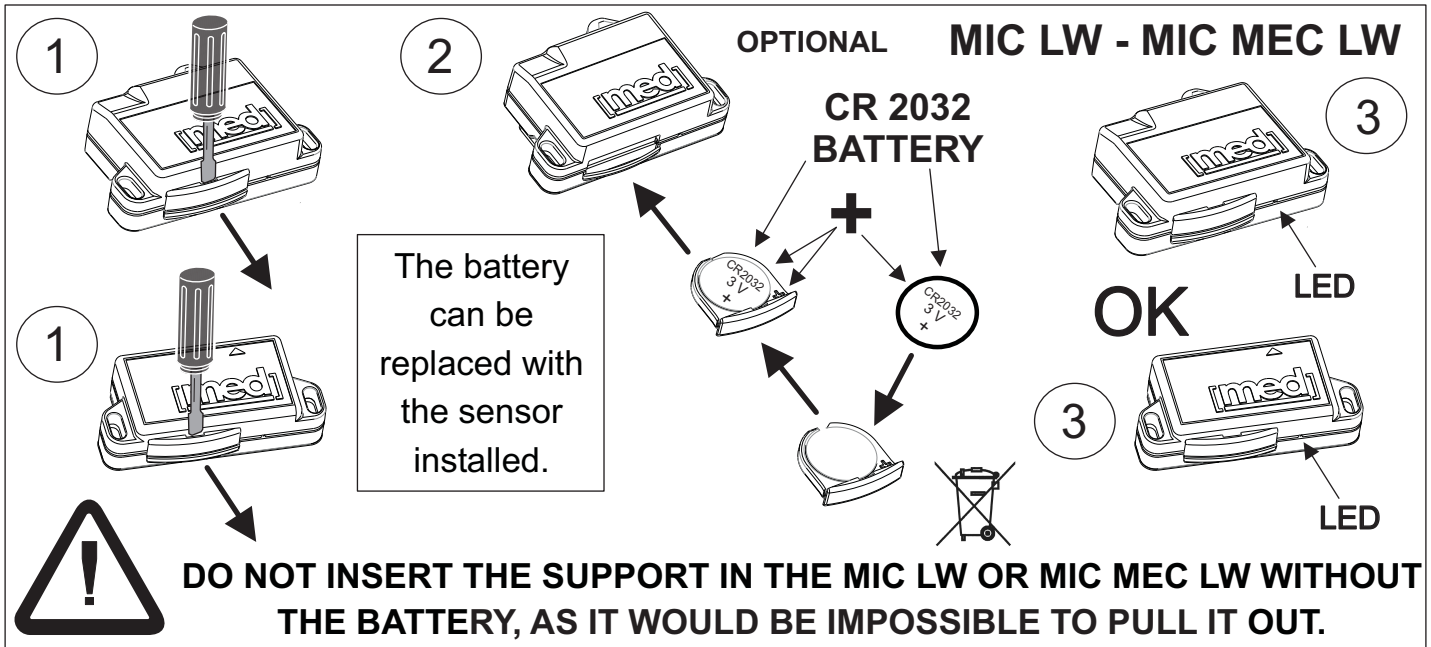
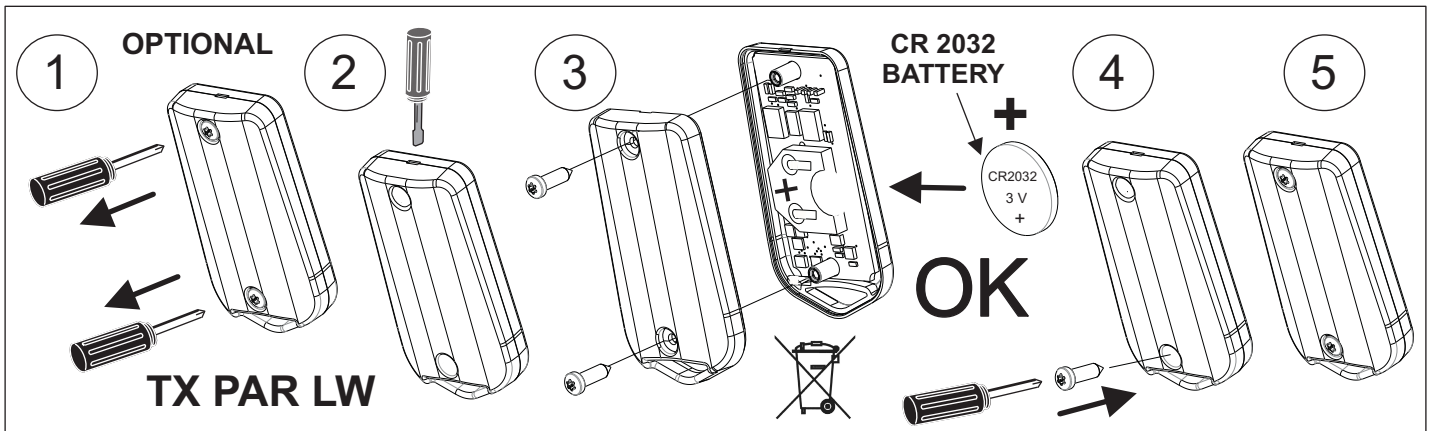

TECHNICAL FEATURES

MED 11.5 LW central unit

Feeding voltage:	12 Vdc (nominal) 8 / 16 Vdc
Current absorption: (average values)	< 12 mA (activated system, first 8 days) < 10 mA (following days) < 10 mA (at rest)
Place:	cockpit
Temperature range:	from -40 °C to +85 °C
Protection:	IP 40 (IEC 529 1989) DIN 40050 EN 60529
Direction indicators output with relay on 2 wires:	10 A + 10 A
Direction indicators output on a single wire:	negative impulse - 0,7 A
Relay for electrical cut off:	10 A continuously - 30 A for 30 seconds
Timed / excludable / fixed status output:	0.7 A
Additional alarm output:	0.7 A
Doors closing / exit possible to be cut out output:	negative, 0.7 A
Doors opening output:	negative, 0.5 A
Dimensions:	98 x 71 x 30 mm

CHD 400 KEYS (optional) - It is possible to use up to 4 pieces simultaneously.

Life:	unlimited
Temperature range:	from -40 °C to +85 °C
Protection:	IP 40 (IEC 529 1989) DIN 40050 EN 60529
Rolling-Code combinations:	more than 18 billions of billions

SIR 050 siren (optional) - (self-powered siren with buzzer inside)

Feeding voltage:	12 Vdc (nominal) - 8 / 16 Vdc
Current absorption:	1 mA at rest - 1 mA (activated system) (average values)
Temperature range:	from -40 °C to +85 °C
Protection:	IP 67 (IEC 529 1989) DIN 40050 EN 60529

SIR 070.LW siren (optional) - (self-powered wireless siren with buzzer inside)

Feeding voltage:	12 Vdc (nominal) - 8 / 16 Vdc
Current absorption:	2 mA at rest - in alarm: 180 mA (average) 400 mA (maximum)
Temperature range:	from -40 °C to +85 °C
Protection:	IP 67 (IEC 529 1989) DIN 40050 EN 60529

TX 4000 LW remote control (optional) - It is possible to use up to 4 pieces simultaneously.

Temperature range:	from -20 °C to +85 °C
Protection:	IP 67 (IEC 529 1989) - DIN 40050 - EN 60529
Rolling-Code combinations:	more than 18 billions of billions
Dimensions:	50 x 30 x 10 mm

TX PAR LW remote control (optional) - It is possible to use up to 4 pieces simultaneously.

Lithium battery / life:	CR 2032 - 3 Volt / about 2 years
Temperature range:	from -20 °C to +85 °C
Protection:	IP 54 (IEC 529 1989) - DIN 40050 - EN 60529
Rolling-Code combinations:	more than 18 billions of billions
Dimensions:	70 x 39 x 14 mm

MIC LW - MIC MEC LW (optional) - (max. n. 30 + 10 choked sensors)

Lithium battery / life:	CR 2032 - 3 Volt / about 1 year
Temperature range:	from -20 °C to +85 °C
Place / Protection:	cockpit / IP 40 (IEC 529 1989) - DIN 40050 - EN 60529
Rolling-Code combinations:	more than 18 billions of billions
Dimensions:	60 x 30 x 16 mm (MIC LW) - 60 x 44 x 18 mm (MIC MEC LW)

SEN INFRA LW - SEN INFRA 360 LW (optional) - It is possible to use up to 2 pieces simultaneously.

Temperature range:	from -20 °C to +50 °C
Lithium battery / life:	CR 123 A - 3 Volt - 1300 mA h / about 1 year
Place / Protection:	cockpit / IP 40 (IEC 529 1989) - DIN 40050 - EN 60529
Rolling-Code combinations:	more than 18 billions of billions
Dimensions:	115 x 62 x 50 mm (INFRA) - 120 x 120 x 40 mm (INFRA 360)

SEN GAS LW (optional) - It is possible to use up to 3 pieces simultaneously.

Feeding voltage:	12 V (nominal)
Current absorption:	10 mA (at rest) - 12 mA (in alarm)
Alarm output:	negative, max 50 mA
Temperature range / Humidity:	from -10 °C to +40 °C / from 30 to 95 %
Operation threshold:	300 PPM within 3 minutes . Reference EN50291
Heating time:	90 sec.
Place / Protection:	cockpit / IP 40 (IEC 529 1989 - DIN 40050 - EN 60529)
Detector life: / Dimensions:	10 years / 60 x 60 x 20 mm

CERTIFICATO DI INSTALLAZIONE - INSTALLATION CERTIFICATE

Il sottoscritto, Thendersigned: _____

Installatore CERTIFICA di aver eseguito PERSONALMENTE il montaggio del DISPOSITIVO descritto qui di seguito, conformemente alle istruzioni del fabbricante.

Installed CERTIFIES that the fitting of the DEVICE described below was carried out by him PERSONALLY, in accordance with the instructions of the manufacturer.

Descrizione del VEICOLO - Description of the VEHICLE:

MARCA, TRADEMARK: _____ MODELLO, TYPE: _____

NUMERO di SERIE, SERIAL NUMBER: _____

NUMERO di IMMATRICOLAZIONE, REGISTRAZION NUMBER: _____

Descrizione dell'ALLARME secondo il Regolamento ECE 97 R (Equivalente alla Direttiva Europea 95/56/CE):
Description of the ALARM as for European Standards 97 R (Equivalent to European Directive 95/56/EC):

Modello, Type

Matricola, Registration

MED 11.5

SIR

SENSORE RADAR, Yes - Sì No - No
RADAR SENSOR

ALTRO / OTHER

Applicare nei riquadri le etichette adesive fornite in confezione con i dati indicati e completare il modulo.
Apply the supplied labels with the relevant data and complete the form.

Installato a, Installed at: _____ Il, On: _____

Indirizzo completo dell'installatore,
Full address of installer:

TIMBRO, STAMP

FIRMA DELL'INSTALLATORE, SIGNATURE: _____

AVVERTENZE GENERALI PER L'UTENTE: DA CONSERVARE A BORDO DEL VEICOLO

- L'INSTALLAZIONE deve essere eseguita da PERSONALE QUALIFICATO, secondo le istruzioni specifiche.
- L'INSTALLATORE DEVE rilasciare al PROPRIETARIO del veicolo il presente CERTIFICATO DI INSTALLAZIONE completamente compilato e firmato, **valido anche per la GARANZIA del prodotto**.
- L'INSTALLAZIONE di un DISPOSITIVO di ALLARME per veicoli secondo la Norma **97 R** comporta:
 1. Il collegamento di TUTTI i pulsanti di porte, cofano e baule, aggiungendo quelli mancanti.
 2. Il collegamento di un AVVISATORE ACUSTICO.
 3. Se è previsto il SENSORE RADAR, deve essere indicato nel presente modulo.

A.E.B. S.p.A. declina ogni responsabilità e sospende la GARANZIA in caso di utilizzo improprio del prodotto o di parte di esso, di manomissione o di abbinamento a dispositivi non previsti.

GENERAL WARNINGS FOR THE USER: PRESERVE INSIDE THE VEHICLE

- INSTALLATION must be conducted by QUALIFIED PERSONNEL and according to the instructions.
- The INSTALLED MUST provide the OWNER of the vehicle with the present INSTALLATION CERTIFICATE, completed in full and signed. **Valid also for the guarantee of the product.**
- INSTALLATION of an ALARM DEVICE for vehicles in accordance with the **European Standard 97 R** requires:
 1. The connection of ALL the door, hood, and boot buttons, adding those that are missing.
 2. The connection of an ACOUSTIC SIGNALER.
 3. If the alarm system includes a RADAR SENSOR this must be indicated in the present form.

A.E.B. S.p.A. declines all responsibility and withdraws the GUARANTEE / WARRANTY in cases of: the improper use of the product or part there of, tampering with the product, its combination with devices for which it was not specifically designed.

SI PREGA DI SCRIVERE IN STAMPATELLO - PLEASE WRITE IN BLOCK LETTERS

Tutti i diritti riservati. © 2014 AEB S.p.A. a socio unico All rights reserved. © 2014 AEB S.p.A. a single member
Con riserva di modifiche e di indicazioni errate. Company. Subject to changes and incorrect information.



AUTOMOTIVE SOLUTIONS

MED 11.5 LW

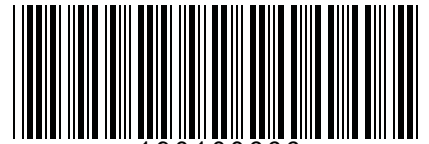

190100666

NUMERO DI OMOLOGAZIONE E APPROVAL NUMBER E
NUMERO HOMOLOGATION E
NÚMERO DE HOMOLOGACIÓN E

APRILE - APRIL
AVRIL - APRIL
2015

ISTRUZIONE DI MONTAGGIO - ITALIANO
FITTING GUIDE - ENGLISH
INSTRUCTIONS DE MONTAGE - FRANCAIS
INSTRUCCIONES DE MONTAJE - ESPAÑOL

SENSORI RADAR
ULTRASONIC SENSORS
CAPTEURS RADAR
SENSORES RADAR

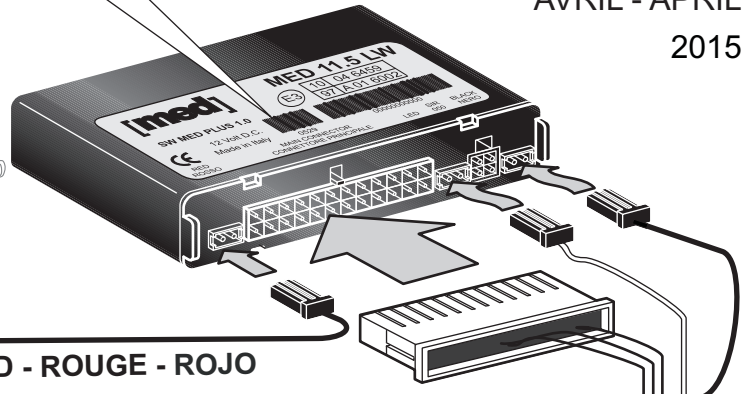
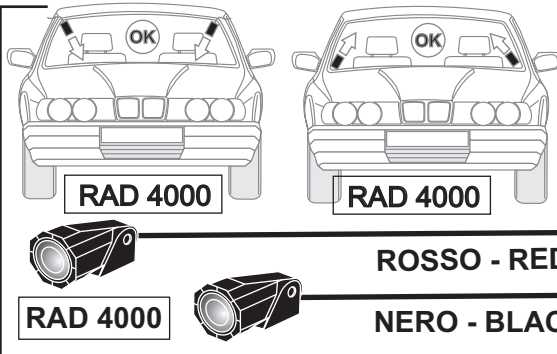

ROSSO - RED - ROUGE - ROJO
NERO - BLACK - NOIR - NEGRO
CAV 11.5

ALIMENTAZIONE - FEEDING
ALIMENTATION - ALIMENTACIÓN

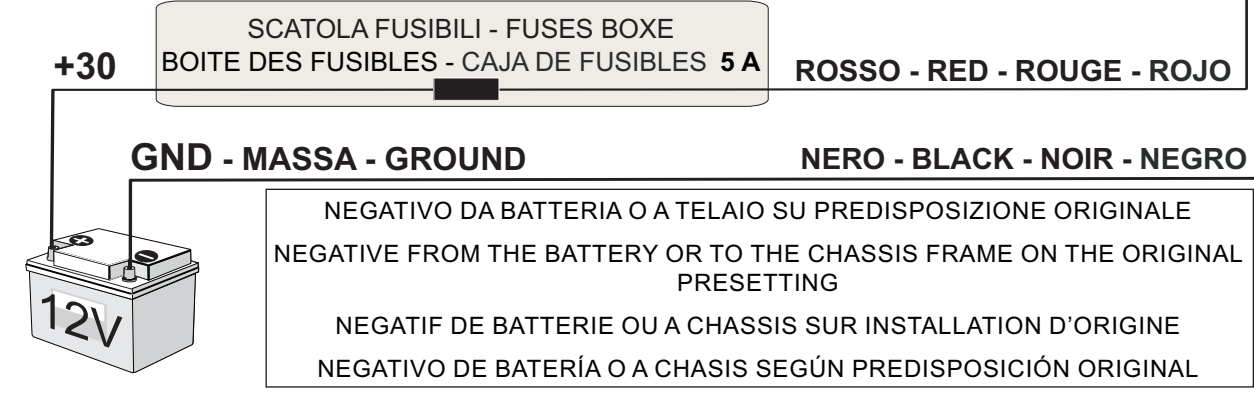

NEGATIVO DA BATTERIA O A TELAIO SU PREDISPOSIZIONE ORIGINALE
NEGATIVE FROM THE BATTERY OR TO THE CHASSIS FRAME ON THE ORIGINAL PRESETTING
NEGATIF DE BATTERIE OU A CHASSIS SUR INSTALLATION D'ORIGINE
NEGATIVO DE BATERÍA O A CHASIS SEGÚN PREDISPOSICIÓN ORIGINAL

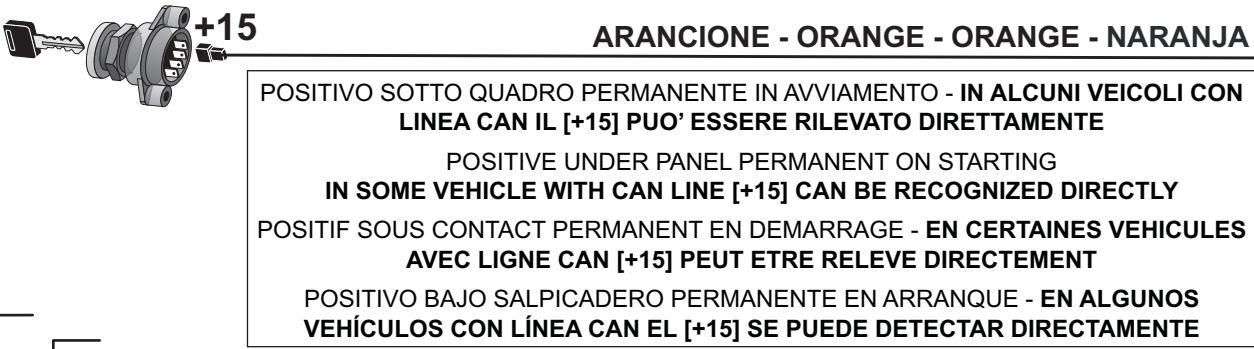

POSITIVO SOTTO QUADRO PERMANENTE IN AVVIAMENTO - IN ALCUNI VEICOLI CON LINEA CAN IL [+15] PUO' ESSERE RILEVATO DIRETTAMENTE
POSITIVE UNDER PANEL PERMANENT ON STARTING
IN SOME VEHICLE WITH CAN LINE [+15] CAN BE RECOGNIZED DIRECTLY
POSITIF SOUS CONTACT PERMANENT EN DEMARRAGE - EN CERTAINES VEHICULES AVEC LIGNE CAN [+15] PEUT ETRE RELEVÉ DIRECTEMENT
POSITIVO BAJO SALPICADERO PERMANENTE EN ARRANQUE - EN ALGUNOS VEHÍCULOS CON LÍNEA CAN EL [+15] SE PUEDE DETECTAR DIRECTAMENTE

LED/PULSANTE
LED/BUTTON
LED/BOUTON
LED/TECLA

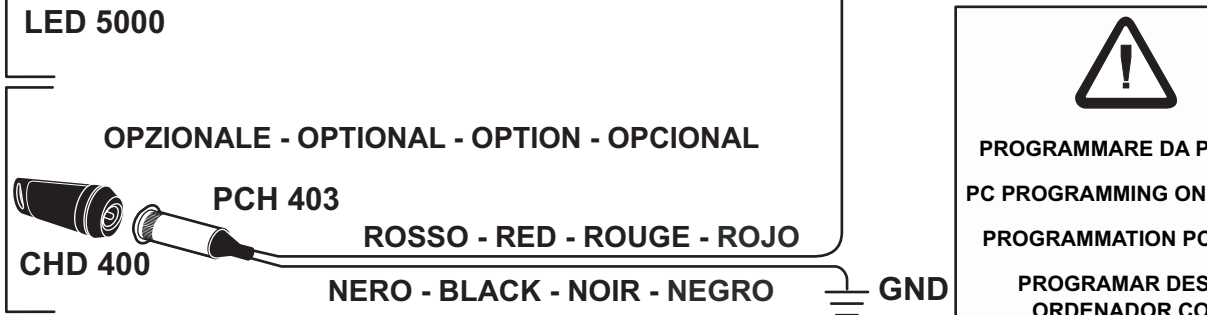

KEY EMERGENCY
CHIAVE EMERGENZA
CLE D'EMERGENCE
LLAVE EMERGENCIA

NELLE PAGINE SEGUENTI GLI ALTRI COLLEGAMENTI
MORE CONNECTIONS CAN BE FOUND ON THE FOLLOWING PAGES
LES AUTRES CONNEXIONS SE TROUVENT DANS LES PAGES SUIVANTES
EN LAS PÁGINAS SIGUIENTES LAS OTRAS CONEXIONES

PROGRAMMARE DA PC CON
PC PROGRAMMING ONLY WITH
PROGRAMMATION PC AVEC
PROGRAMAR DESDE
ORDENADOR CON
KIT SK PLUS
SW MED PLUS

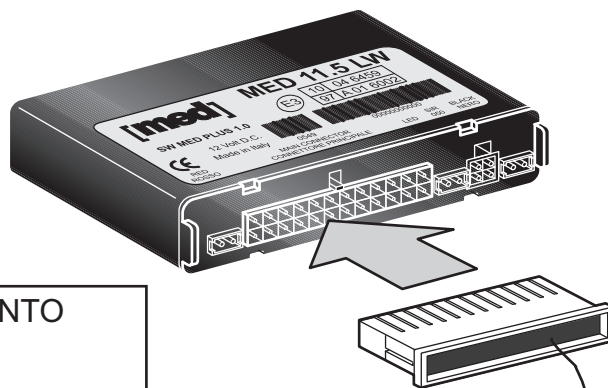

- FILI DI INTERFACCIAMENTO ALL'IMPIANTO ORIGINALE DEL VEICOLO.
 DA COLLEGARE SEGUENDO GLI SCHEMI SPECIFICI ALLEGATI O RIPORTATI NELLE SCHEDE VEICOLI NEL SITO INTERNET MED www.medautomotive.it.

- NELLE SCHEDE DI COLLEGAMENTO SONO RIPORTATE ANCHE LE AVVERTENZE SPECIFICHE E LE "ABILITAZIONI" DA EFFETTUARE ALLA CENTRALE O AL VEICOLO.

- INTERFACING WIRES TO THE ORIGINAL VEHICLE SYSTEM.
 TO BE CONNECTED FOLLOWING THE ENCLOSED SPECIFIC DIAGRAMS OR THESE INSERTED IN THE MED WEBSITE www.medautomotive.it UNDER THE VEHICLES DIAGRAMS.

- IN THE WIRING DIAGRAMS ARE MENTIONNED ALSO THE SPECIFIC WARNINGS AND THE VEHICLE / CENTRAL UNIT POSSIBLE PROGRAMMINGS.

- LES FILS D'INTERFACE AVEC LE SYSTEME ORIGINAL DU VEHICULE SONT A BRANCHER SELON LES DIAGRAMMES DE CONNEXIONS SPECIFIQUES JOINTS OU SELON LE SCHEMAS DANS LE SITE INTERNET MED www.medautomotive.it.

- DANS LES DIAGRAMMES DES CONNEXIONS SONT INDIQUEES AUSSI LES AVERTISSEMENTS ET LES POSSIBLES HABILITATIONS DE LA CENTRALE OU DU VEHICULE.

- CONDUCTORES DE INTERCONEXIÓN AL SISTEMA ORIGINAL DEL VEHÍCULO.
 PARA CONECTAR SIGUIENDO LOS ESQUEMAS ADJUNTOS O INCLUIDOS EN LAS FICHAS DE LOS VEHÍCULOS EN EL SITO INTERNET MED www.medautomotive.it.

- EN LAS FICHAS DE CONEXIÓN FIGURAN LAS ADVERTENCIAS ESPECÍFICAS Y LAS HABILITACIONES A EFECTUAR EN LA CENTRAL O EL VEHÍCULO.

BLU/ROSSO - BLUE/RED
BLEU FONCE/ROUGE AZUL/ROJO
BLU/GIALLO BLUE/YELLOW
BLEU FONCE/JAUNE AZUL/AMARILLO
BLU - BLUE BLEU FONCE - AZUL
GIALLO/ROSSO YELLOW/RED JAUNE/ROUGE AMARILLO/ROJO
GIALLO/AZZURRO YELLOW/LIGHT BLUE JAUNE/BLEU CIEL AMARILLO/CELESTE
GIALLO - YELLOW JAUNE - AMARILLO

PULSANTI - BUTTONS - BOUTONS - TECLAS

ATTENZIONE: NEI VEICOLI CON "CAN" I PULSANTI POSSONO ESSERE RILEVATI DIRETTAMENTE DA ESSO. VERIFICARE SUL VEICOLO.

WARNING: IN THE VEHICLE WITH "CAN" SYSTEM THE BUTTONS CAN BE CONTROLLED DIRECTLY BY IT. CHECK.

AVERTISSEMENTS: SUR LES VEHICULES AVEC "CAN" LES BOUTONS PEUVENT ETRE RELEVES PAR ELLE. VERIFIER.

ATENCIÓN: EN LOS VEHÍCULOS CON "CAN" LAS TECLAS PUEDEN SER DETECTADAS DIRECTAMENTE POR ÉSTA. COMPROBARLO EN EL VEHÍCULO.

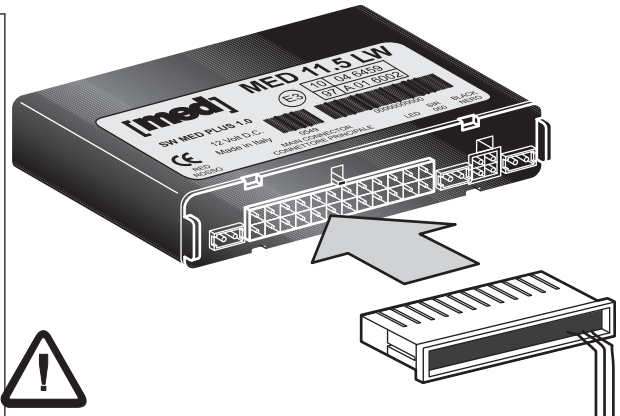

AZZURRO - LIGHT BLUE - BLEU CIEL - CELESTE IN 2

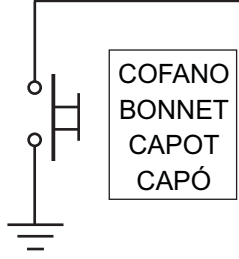

STANDARD - INGRESSO PULSANTI NEGATIVO, ISTANTANEO, ESCLUDIBILE.

STANDARD - BUTTONS INPUT, INSTANTANEOUS, POSSIBLE TO BE CUT OUT, FOR NEGATIVE SIGNAL.

STANDARD - ENTREE INSTANTANEE, POSSIBLE A ETRE EXCLUE, POUR SIGNAL NEGATIF.

ESTÁNDAR - ENTRADA TECLAS NEGATIVA, INSTANTÁNEA, EXCLUIBLE

STANDARD - INGRESSO PULSANTI NEGATIVO, PROGRAMMABILE: RITARDATO A 30 / 50 SECONDI, ISTANTANEO, ESCLUDIBILE.

STANDARD - PROGRAMMABLE BUTTONS INPUT: DELAIED OF 30 / 50 SECONDS, INSTANTANEOUS, POSSIBLE TO BE CUT OUT, FOR NEGATIVE SIGNAL.

STANDARD - ENTREE TOUCHES PROGRAMMABLE: RETARDEE DE 30 / 50 SECONDES, INSTANTANEE, POSSIBLE A ETRE EXCLUE, POUR SIGNAL NEGATIF.

ESTÁNDAR - ENTRADA TECLAS NEGATIVA, PROGRAMABLE: RETARDADA A 30 / 50 SEGUNDOS, INSTANTÁNEA, EXCLUIBLE.

IN 1

**AZZURRO/BIANCO
LIGHT BLUE/WHITE
BLEU CIEL/BLANC
CELESTE/BLANCO**

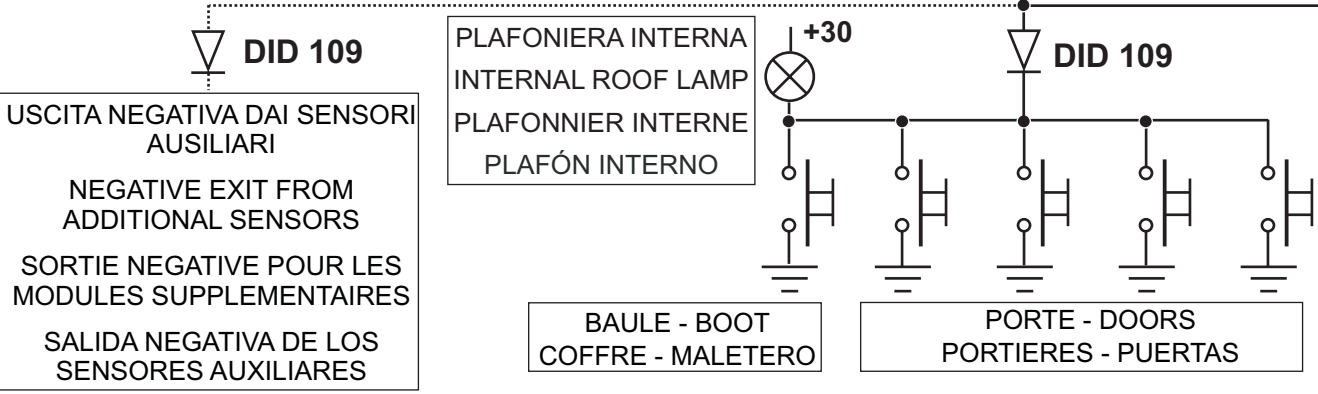

ANTENNA - ANTENNE - ANTENA

Non tagliare. Non allungare.
Mantenere disteso, distante dagli altri fili e dalle parti metalliche del veicolo.

Do not cut. Do not stretch.
Keep laid out flat, away from the other wires and metal parts of the vehicle.

Non pas couper. Non pas allonger. Maintenir étalé, à bonne distance des autres fils et des parties métalliques du véhicule.

No cortar. No alargar.
Mantenerlo extendido, distante de los otros conductores y de Las partes metálicas del vehículo.



**BIANCO/NERO
WHITE/BLACK
BLANC/NOIR
BLANCO/NEGRO**

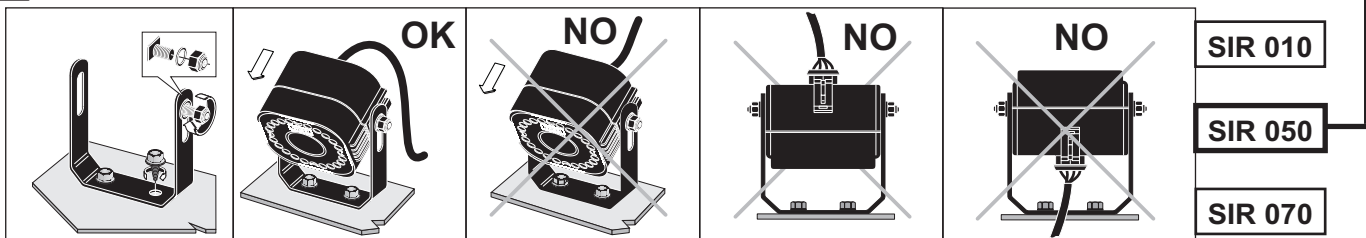
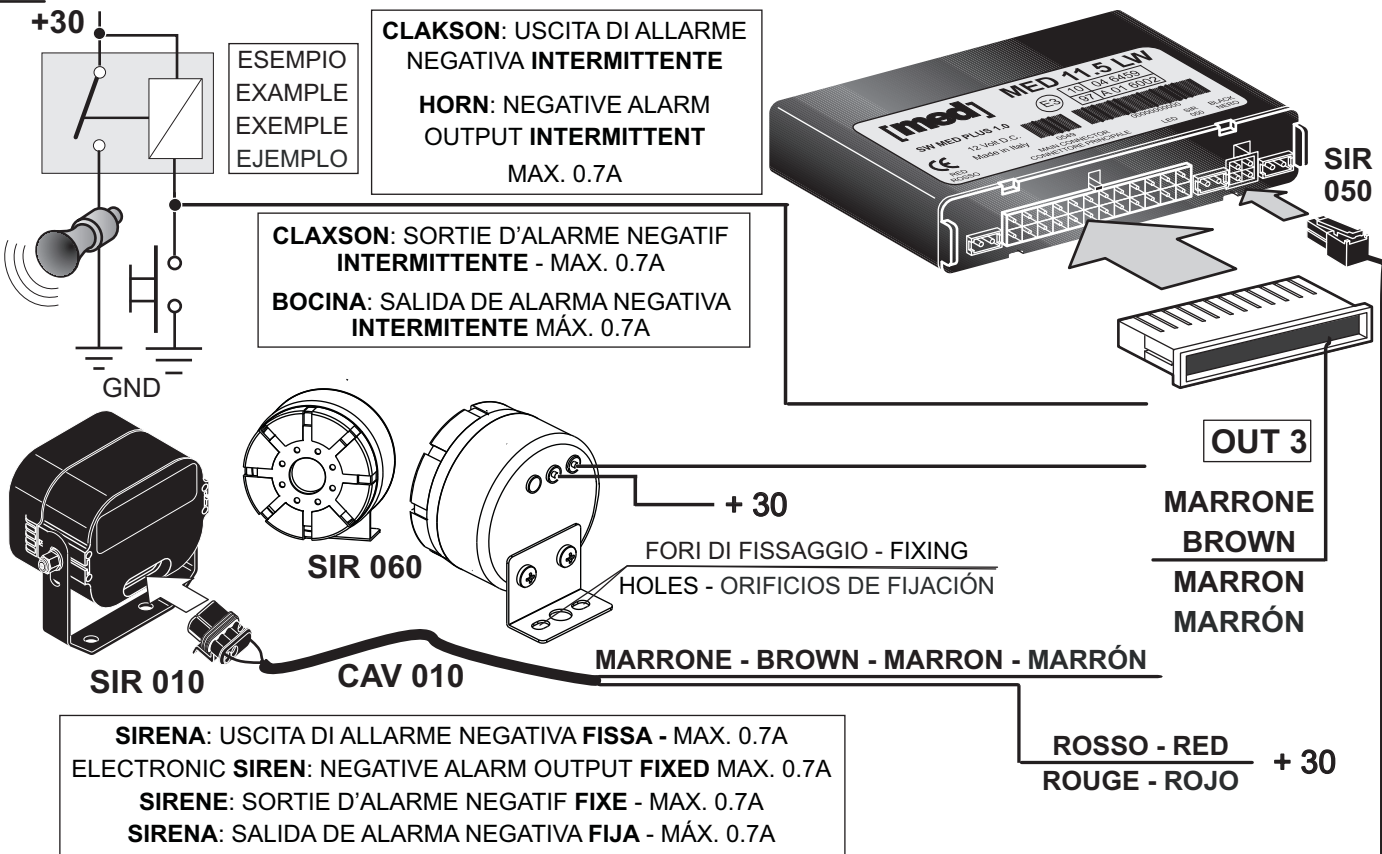

FISSARE CON LA TROMBA INCLINATA VERSO IL BASSO, COL CAVO CHE SALE DAL BASSO, DISTANTE DA FONTI DI CALORE INTENSO (COLLETTORI DI SCARICO, ETC.), PROTETTA DA SPRUZZI CONSISTENTI DI LIQUIDI.

FIXER EN ORIENTANT LE PAVILLON VERS LE BAS, AVEC LE CABLE ARRIVANT DU BAS, A L'ABRI DES SOURCES DE CHALEUR EXCESSIVES (COLLECTEURS D'ECHAPPEMENT, ETC.), ET A L'ABRI DES ECLABOUSSURES DE LIQUIDES.

FASTEN WITH HORN SLIGHTLY ANGLED DOWNWARDS, WITH THE CABLE COMING UP FROM BELOW, AWAY FROM STRONG HEAT SOURCES (EXHAUSTS, ETC) PROTECTED AGAINST HEAVY LIQUID SPRAYS.

FIJARLA CON LA TROMPETA INCLINADA HACIA ABAJO, CON EL CABLE SALIENDO POR ABAJO, LEJOS DE FUENTES DE CALOR (COLECTORES DE ESCAPE, ETC.), PROTEGIDA DE LAS SALPICADURAS.

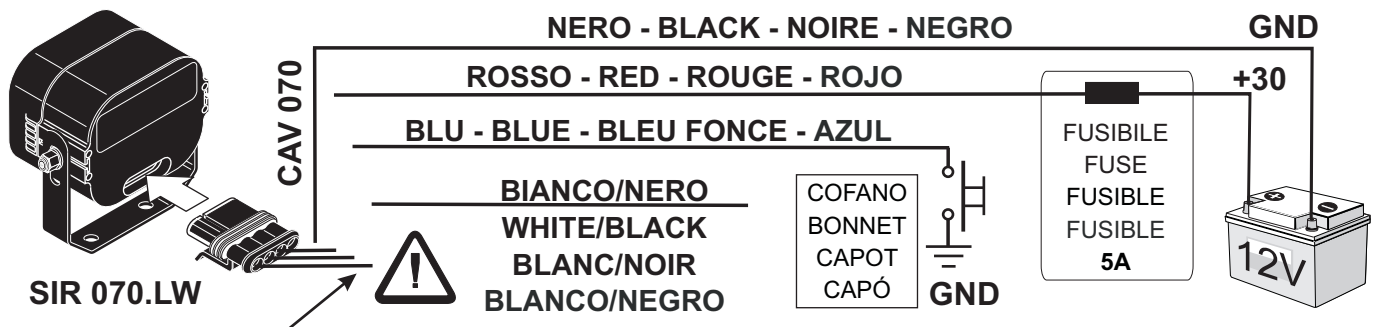

ATTENZIONE: Antenna. Non tagliare. Non allungare. Mantenere disteso, distante dagli altri fili e dalle parti metalliche del veicolo.

WARNING: Antenna. Do not cut. Do not stretch. Keep laid out flat, away from the other wires and metal parts of the vehicle.

ATTENTION: Antenne. Non pas couper. Non pas allonger. Maintenir étalé, à bonne distance des autres fils et des parties métalliques du véhicule.

ATENCIÓN: Antena. No cortar. No alargar. Mantenerlo extendido, distante de los otros conductores y de las partes metálicas del vehículo.

MASSA - NEGATIVO DA BATTERIA O A TELAIO SU PREDISPOSIZIONE ORIGINALE

GROUND: NEGATIVE FROM THE BATTERY OR TO THE CHASSIS FRAME ON THE ORIGINAL PRESETTING

NEGATIF: NEGATIF DE BATTERIE OU A CHASSIS SUR INSTALLATION D'ORIGINE

MASA - NEGATIVO DE BATERÍA O A CHASIS SEGÚN PREDISPOSICIÓN ORIGINAL

MODALITA' STANDARD - STANDARD SETTING

MODALITE STANDARD - MODO ESTÁNDAR

TRAMITE COMANDO UNICO SU DI 1 SOLO FILO

ATTIVARE IL FUNZIONAMENTO ADATTO:

CON IMPULSI DI ATTIVAZIONE / DISATTIVAZIONE (IMPOSTAZIONE STANDARD) O SEGNALE CONTINUO.

BY A SINGLE CONTROL ON ONE WIRE ONLY ACTIVATE THE RIGHT WAY OF FUNCTIONING: WITH ACTIVATING / DESACTIVATING IMPULSES (STANDARD SETTING) OR WITH CONTINUOUS SIGNAL.

PAR UNE COMMANDE UNIQUE SUR UN FIL SEULEMENT

ACTIVER LE FONCTIONNEMENT INDIQUE: AVEC IMPULSIONS DE BRANCHEMENT / DEBRANCHEMENT (CONFIGURATION STANDARD) OU AVEC SIGNAL CONTINU.

MEDIANTE MANDO ÚNICO CON 1 SOLO CONDUCTOR ACTIVAR EL FUNCIONAMIENTO ADECUADO: CON IMPULSOS DE ACTIVACIÓN / DESACTIVACIÓN (CONFIGURACIÓN ESTÁNDAR) O SEÑAL CONTINUA.

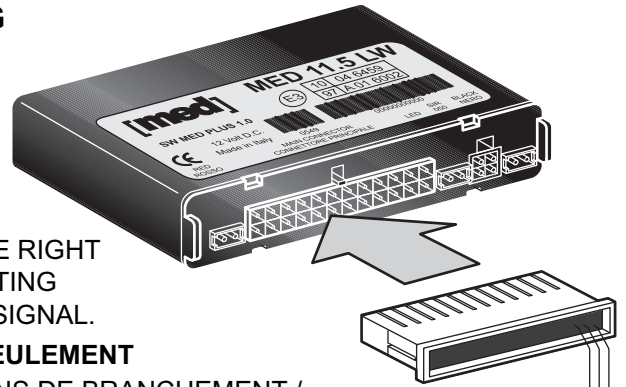

INDICATORI DI DIREZIONE - DIRECTION INDICATORS - CLIGNOTANTS

MODULO FRECCHE ORIGINALE
ORIGINAL DIRECTION INDICATOR MODULE
MODULE CLIGNOTANTS ORIGINAL
MÓDULO INDICADORES DE DIRECCIÓN ORIGINAL

ESEMPIO
EXAMPLE
EXEMPLE
EJEMPLO



BLINKER HAZARD
COMANDO NEGATIVO SU FILO SINGOLO
INDICATORI DI DIREZIONE
NEGATIVE CONTROL ON A DIRECTION INDICATORS SINGLE WIRE
COMMANDE NEGATIF SUR UN FIL DES CLIGNOTANTS
MANDO NEGATIVO CON UN SOLO CONDUCTOR INDICADORES DE DIRECCIÓN

VERDE/NERO - GREEN/BLACK - VERT/NOIR - VERDE/NEGRO

VERDE - GREEN - VERT - VERDE

(FEEDBACK - COLLEGARE AD UNA LAMPADA OPPURE ISOLARE)
(FEEDBACK - TO CONNECT TO ONE LAMP OR INSULATE IT)
(FEEDBACK - A CONNECTER A UNE LAMPES OU A ISOLER)
(FEEDBACK - CONECTAR A UNA LÁMPARA O AISLAR)

DA ISOLARE SEPARATAMENTE
TO INSULATE SEPARATELY
A ISOLER SEPAREMENT
A AISLAR SEPARADAMENTE

VERDE/ROSSO - GREEN/RED - VERT/ROUGE - VERDE/ROJO

OPPURE - OR - OU - O BIEN

TRAMITE RELE' INTERNO - DA ATTIVARE TRAMITE PROGRAMMAZIONE

BY INTERNAL RELAY - TO BE ACTIVATED BY PROGRAMMING

PAR UN RELAI INTERNE - A ACTIVER PAR PROGRAMMATION

POR RELÉ INTERNO - ACTIVAR CON PROGRAMACIÓN

MODULO FRECCHE ORIGINALE
ORIGINAL DIRECTION INDICATOR MODULE
MODULE CLIGNOTANTS ORIGINAL
MÓDULO INDICADORES DE DIRECCIÓN ORIGINAL
FUSIBILE - FUSE - FUSIBLE - FUSIBLE
20 A

ALIMENTAZIONE FRECCHE COMUNE NEGATIVO O POSITIVO [+30] SOTTO FUSIBILE
DIRECTION INDICATORS FEEDING COMMON NEGATIVE OR POSITIVE [+30] UNDER FUSE
ALIMENTATION DES CLIGNOTANTS COMMUNE NEGATIF OU POSITIF [+30] SOUS FUSIBLE
ALIMENTACIÓN INDICADORES COMÚN NEGATIVO O POSITIVO [+30] DEBAJO DEL FUSIBLE

VERDE/ROSSO - GREEN/RED - VERT/ROUGE - VERDE/ROJO

VERDE - GREEN - VERT - VERDE

VERDE/NERO - GREEN/BLACK - VERT/NOIR - VERDE/NEGRO

ESEMPIO
EXAMPLE
EXEMPLE
EJEMPLO



MAX 10 A + 10 A

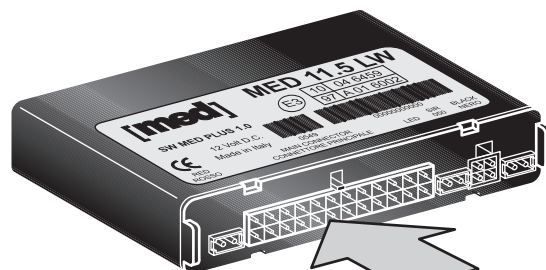

INTERRUZIONE ELETTRICA - ELECTRICAL
CUTOFF - COUPURE ELECTRIQUE
INTERRUPCIÓN ELÉCTRICA

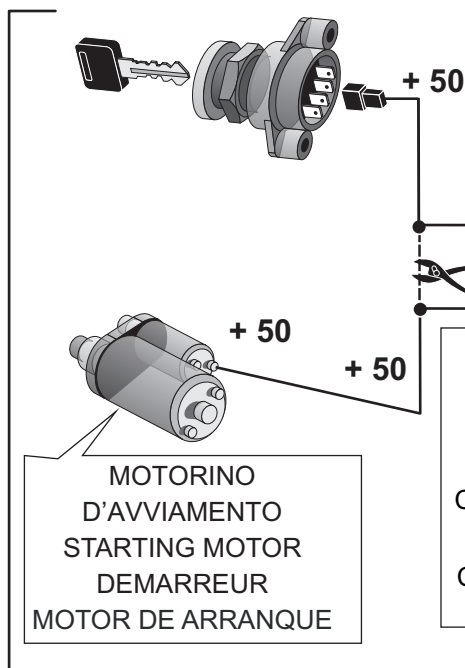

MOTORINO
D'AVVIAMENTO
STARTING MOTOR
DEMARREUR
MOTOR DE ARRANQUE

BIANCO - WHITE - BLANC - BLANCO

BIANCO - WHITE - BLANC - BLANCO

CONTATTO **NC** - NORMALMENTE CHIUSO **15A** CONTINUI
MAX. **20 A** PER 30 SECONDI

 **NC CONTACT** - NORMALLY CLOSED
15ACONTINUOS - MAX. **20 A** FOR 30 SECONDS

CONTACT **NF** - NORMALEMENT FERME - **15A** CONTINUS MAX.
20 A POUR 30 SECONDES

CONTACTO **NC** - NORMALMENTE CERRADO **15A** CONTINUOS
MÁX. **20 A** DURANTE 30 SEGUNDOS

MUX

USCITA MUX PER IMMOBILIZZATORI DEDICATI MED
MUX EXIT FOR DEDICATED MED IMMOBILIZERS
SORTIE MUX POUR LES IMMOBILISATEURS DEDIES MED
SALIDA MUX PARA INMOVILIZADORES DEDICADOS MED

VIOLA - PURPLE - VIOLETTE - VIOLETA

USCITA DI STATO
STATUS EXIT
SORTIE D'ETAT
SALIDA DE ESTADO

SEGNALE DI STATO NEGATIVO FISSO, ESCLUDIBILE PER MODULI
SUPPLEMENTARI O TEMPORIZZATO PER PILOTARE LA SALITA VETRI - MAX. 0.7 A

NEGATIVE STATUS EXIT FIXED / CUTTING OUT FOR ADDITIONAL SENSORS OR
TIMED FOR THE OPTIONAL ELECTRICAL WINDING MODULES - MAX. 0.7 A

SORTIE D'ETAT NEGATIVE FIXE, DESACTIVABLE POUR LES MODULES
SUPPLEMENTAIRES OU TEMPORISEE POUR LES MODULES LEVE VITRES
OPTIONELLES - MAX. 0.7 A

SEÑAL DE ESTADO NEGATIVA FIJA, EXCLUIBLE PARA MÓDULOS
ADICIONALES O TEMPORIZADA PARA PILOTAR ELEVACIONES - MÁX. 0.7 A

OUT 4

GRIGIO
GREY
GRIS
GRIS

CHUSURA CENTRALIZZATA
CENTRAL DOOR LOCKING
FERMETURE CENTRALISEE
CIERRE CENTRALIZADO

USCITA NEGATIVA: CHIUSURA PORTE O STATO ESCLUDIBILE PER MODULI
OPZIONALI - MAX. 0.7 A

NEGATIVE EXIT: DOORS LOCKING OR POSSIBLE TO BE CUT OUT TO CONTROL
THE ADDITIONAL MODULES - MAX. 0.7 A

SORTIE NEGATIVE: FERMETURE PORTES OU POUVANT ETRE EXCLUE POUR
PILOTER LES MODULES SUPPLEMENTAIRES - MAX. 0.7 A

SALIDA NEGATIVA: CIERRE PUERTAS O ESTADO EXCLUIBLE PARA MÓDULOS
OPCIONALES - MÁX. 0.7 A

OUT 1

GRIGIO/NERO
GREY/BLACK
GRIS/NOIR
GRIS/NEGRO

USCITA NEGATIVA PER APERTURA PORTE - MAX. 0.7 A
DOORS OPENING NEGATIVE EXIT - MAX. 0.7 A

SORTIE NEGATIVE: OUVERTURE PORTES - MAX. 0.7 A
SALIDA NEGATIVA PARA APERTURA PUERTAS - MÁX. 0.7 A

OUT 2

ROSA/NERO - PINK/BLACK
ROSE/NERO - ROSA/NEGRO

- **LED/PULSANTE** per segnalazioni di servizio, programmazioni, codice di emergenza.
Su questo cavo può essere collegata la presa **PCH 403** per la chiave di emergenza **CHD 400** (opzionale).
- **Sensori radar.** Nelle versioni con radar, collegare i sensori **RAD 4000**, oppure escluderli definitivamente.
- **ANTENNA:** (pin **5** - Filo **Bianco/Nero**) **Non tagliare. Non allungare.** 
Mantenere disteso, distante dagli altri fili e dalle parti metalliche del veicolo.

ALIMENTAZIONE

- pin **3** - Filo **Rosso** Positivo diretto sotto fusibile da **5A** per alimentazione centrale.
- pin **15** - Filo **Nero** Negativo diretto da batteria o a telaio, in punti predisposti dal costruttore del veicolo.
- pin **16** - Filo **Arancione** Positivo sotto quadro [+15] permanente in avviamento.

ATTENZIONE: in alcuni veicoli con linea "CAN" il [+15] può essere rilevato direttamente tramite "CAN". VERIFICARE SUL VEICOLO.

INGRESSI PULSANTI PORTE, COFANO E BAULE - Impostazione standard.

- pin **8** - Filo **Azzurro** - **IN 2:** Ingresso **ISTANTANEO** pulsanti verso negativo (massa).
- pin **7** - Filo **Azzurro/Bianco** - **IN 1:** Ingresso **RITARDATO** all'inserimento (poi istantaneo), verso negativo.

ATTENZIONE:

- **NEI VEICOLI CON LINEA DI TRASMISSIONE DATI "CAN" I PULSANTI POSSONO ESSERE RILEVATI DIRETTAMENTE DA ESSO. VERIFICARE SUL VEICOLO.**
- Tramite PC, KIT SK PLUS e SW MED PLUS è possibile configurare i due ingressi pulsanti analogici **IN1** ed **IN2** per leggere: contatti **NA** (Normalmente Aperti), **NC** (Normalmente Chiusi) verso **massa** o **positivo**, **12** o **24V**.
- Ingressi escludibili separatamente nel caso di malfunzionamento dei pulsanti o dei sensori ausiliari collegati.

INTERFACCIAMENTO IMPIANTO ORIGINALE DEL VEICOLO (Fili pin **10** - **Blu** / pin **11** - **Blu/Rosso** / pin **12** - **Blu/Giallo** / pin **22** - **Giallo** / pin **23** - **Giallo/Rosso** / pin **24** - **Giallo/Azzurro**)

Il sistema rileva tramite uno o più di questi fili sia segnali **analogici** che **digitali** (da linee seriali di trasmissione dati tipo: "**CAN**"). Le indicazioni sui programmi di interfacciamento disponibili, i collegamenti specifici, le avvertenze e le abilitazioni da effettuare sul veicolo o sulla centrale **med** sono riportate nelle schede di collegamento veicoli riportate nel sito internet med **www.medautomotive.it**.

E' sempre possibile per l'installatore aggiornare la centrale per un nuovo veicolo, tramite il cavetto di programmazione **KIT SK PLUS**, il computer ed il relativo **SOFTWARE MED PLUS**.

La lettura dei pulsanti rilevati dalla linea "CAN" può essere esclusa tramite programmazione specifica.

INDICATORI DI DIREZIONE:

ATTENZIONE: PROGRAMMARE PRIMA LA CENTRALE PER IL TIPO DI PILOTAGGIO DESIDERATO (comando negativo su di un filo, Impostazione Standard), **POI EFFETTUARE I COLLEGAMENTI, ONDE EVITARE CORTOCIRCUITI ACCIDENTALI.**

Impostazione STANDARD: TRAMITE COMANDO UNICO SU DI UN SOLO FILO con **IMPULSO** di inizio e di fine lampeggio. Sulle vetture predisposte, la funzione permette di pilotare con un solo filo tutte le lampade degli indicatori di direzione simultaneamente.

- pin **2** - Filo **Verde/Rosso** - **ATTENZIONE: Isolare separatamente.**
- pin **1** - Filo **Verde** - Da collegare ad una qualunque lampada degli Indicatori di Direzione (Feedback).
ATTENZIONE: Se non utilizzato, isolare separatamente.

Collegamento consigliato, che permette di ottimizzarne il pilotaggio (su alcuni veicoli può evitare che si spengano durante il ciclo di allarme, se questi erano già in funzione).

- pin **13** - Filo **Verde/Nero** - **Uscita NEGATIVA, 12 Volt, protetta. Max 700 mA.** Collegare al filo unico di comando simultaneo degli indicatori di direzione (generalmente dietro all'interruttore del BLINKER).

ATTENZIONE:

- Impostare la modalità di comando adatta: es. Comando CONTINUO (segnale costante per tutta la durata del lampeggio) oppure Con IMPULSO di Inizio e Fine lampeggio (il primo impulso attiva il lampeggio, quello successivo lo interrompe).
- Non sempre possono essere attivate le segnalazioni ottiche di inserimento / disinserimento del sistema, oppure queste possono essere costituite da un numero di lampeggi diverso dall'impostazione standard indicata.

TRAMITE RELE' INTERNO - COLLEGAMENTO CLASSICO

DA ATTIVARE TRAMITE SPECIFICA PROGRAMMAZIONE

- pin **2** - Filo **Verde/Rosso** Alimentazione comune positiva o negativa con fusibile (almeno da **20 A**).
- pin **1** - Filo **Verde** Uscita per un canale (lato destro o sinistro).
- pin **13** - Filo **Verde/Nero** Uscita per l'altro canale (lato destro o sinistro).

Per impianti con 4 o più canali, applicare lo schema sopra riportato, inserendo sulle linee un diodo di valore adatto (corrente massima di **3 A** per ogni lampada).

USCITA NEGATIVA DEL SEGNALE DI STATO (pin 4 - Filo Grigio - OUT 4)

Fornisce un segnale negativo ad impianto inserito.

- Fisso (impostazione standard) per attivare il sistema di protezione satellitare o un sensore supplementare.
- TEMPORIZZATO per pilotare la salita vetri tramite i moduli alzacristalli opzionali.
- ESCLUDIBILE unitamente al sensore RADAR per disattivare i moduli se i vetri sono aperti o si è a bordo del veicolo.

CHIUSURA CENTRALIZZATA (pin 14 - Filo Grigio/Nero - OUT 1 / Filo pin 17 - Rosa/Nero - OUT 2)

Pilotaggio diretto chiusura centralizzata per impianti a comando negativo.

Può essere abbinato il modulo opzionale **KIT AP / CH** cod. **674980000** per il comando universale della chiusura centralizzata tramite 2 relè con contatti in scambio. Adatto anche a pilotare i motorini supplementari.

Tempi di apertura / chiusura programmabili come indicato per veicoli con IMPIANTO COMFORT di salita vetri tramite lo stesso filo di chiusura porte o per impianti pneumatici (es. Vecchie vetture AUDI - MERCEDES).

USCITA ESCLUDIBILE PER MODULI SUPPLEMENTARI (pin 14 - Filo Grigio/Nero - OUT 1)

Se non usato per la chiusura centralizzata, può fornire il segnale negativo per alimentare i moduli supplementari (sensore d'urto, antisollevamento) solo attivando il sistema in modo completo.

L'uscita non è presente se lo si attiva in modo parzializzato, quando si è a bordo del veicolo.

USCITA SUPPLEMENTARE DI ALLARME (pin 18 - Filo Marrone - OUT 3) Uscita negativa in allarme.

Fissa (impostazione standard) per attivare una sirena ausiliaria (ad esempio la **SIR 010 / SIR 060**) o il sistema satellitare.

Può essere programmata come intermittente per pilotare il clacson del veicolo (tramite relè).

INTERRUZIONE ELETTRICA (pin 19 / pin 20 - 2 Fili Bianchi)

Contatto **N.C.** (Normalmente Chiuso) del relè interno con portata continua di **15A (20A** massimi per 30 secondi) adatto ad effettuare un'interruzione elettrica per immobilizzare il veicolo.

Può interrompere direttamente il **[+ 50]** (motorino di avviamento) nei veicoli a 12 Volt.

Il relè apre il contatto effettuando un avviamento **[+15] ON** a sistema inserito.

USCITA MUX (pin 9 - Filo Viola) Per pilotare gli immobilizzatori **MED 30.1** o **MED 30.2**.

VALORI STANDARD IMPOSTATI:

Pilotaggio indicatori di direzione:	A filo unico (BLINKER) - Con IMPULSI
Sensore RADAR:	ATTIVO - sensibilità MEDIA Antisabotaggio ATTIVO
Inserimento allarme alla chiusura porte:	ESCLUSO
PRE-ALLARME:	ESCLUSO
Ingressi PULSANTI analogici / CAN:	ATTIVI - IN2 = NA istantaneo, negativo IN1 = NA ritardato 30 sec., Negativo
Cicli di allarme da ingressi pulsanti:	1 CICLO di allarme
Lettura [+15] da can (veicoli predisposti):	ATTIVO
Segnale di STATO:	FISSO, non escludibile
Comando negativo chiusura centralizzata:	ATTIVO
Tempo di APERTURA / CHIUSURA PORTE:	0,8 sec. - comando chiusura porte SINGOLO
Segnalazioni inserimento / disinserimento:	Acustiche: ATTIVE Ottiche da telecomando originale: ESCLUSE
Uscita di ALLARME SUPPLEMENTARE:	FISSA
Inserimento automatico Blocco Motore:	ESCLUSO
Avviamento motore esclusivo con CHD 400:	ESCLUSO
IMPIANTO:	IN SERVIZIO

- **LED / BUTTON** cable for service signalling, programmings, emergency code.
This cable could be connected the key socket **PCH 403** for the **Emergency Key CHD 400** (optional).
- **Ultrasonic sensors**. Version equipped with radar: connect the sensors **RAD 4000** or cut them out permanently.
- **ANTENNA** (pin 5 - **Grey White/Black** wire) **Do not cut. Do not stretch.** 
Keep laid out flat, away from the other wires and metal parts of the vehicle.

FEEDING

- pin 3 - **Red** positive wire to connect directly under the **5A** fuse for the central unit feeding.
- pin 15 - **Black** negative wire to connect directly to the battery or to the frame in hose points already preset by the manufactures.
- pin 16 - Positive **Orange** wire under **[+15]** always on. **WARNING: in some vehicle with "CAN LINE" [+15] can be recognized directly by "CAN". CHECK ON THE VEHICLE.**

DOORS, BONNET, BOOT BUTTONS INPUT - Standard setting.

- pin 8 - **Light Blue** wire - **IN 2 INSTANTENEOUS** buttons input towards the negative signal (ground).
- pin 7 - **Light Blue/White** wire - **IN 1** wire **DELAYED** input on activation (then instantaneous) negative signal.

WARNING:

- **IN THE VEHICLE EQUIPPED WITH "CAN" THE BUTTONS CAN BE CONTROLLED DIRECTLY BY IT. CHECK ON THE VEHICLE.**
- Using a PC and KIT SK PLUS with SW MED PLUS PLUS you can configure the two inputs of the analog buttons IN1 and IN2 in order to read: contacts **NO** (Normally Open), **NC** (Normally Closed) to ground or positive, **12** or **24V**.
- Inputs possible to be cut out separately in case of buttons or additional sensors bad functioning.

INTERFACING OF THE VEHICLE ORIGINAL SYSTEM (pin 10 - Blue / pin 11 - Blue/Red / pin 12 - Blue/Yellow / pin 22 - Yellow / pin 23 - Yellow/Red / pin 24 - Yellow/light Blue wires).

The system detects either **analogical** or **digital** signals by one or more of these wires (from serial lines for data transmission such as: "**CAN**").

All details regarding the possible interfacing programs, the specific connections, the warnings and the vehicle-central unit possible programmings are inserted in the vehicles wiring diagrams included in the med website www.medautomotive.it.

It's always possible to reprogram the central unit connecting the **KIT SK PLUS** to the **PC** using the **SOFTWARE MED PLUS** concerning the necessary vehicle.

The buttons reading detected by this line can be cut out by a specific programming.

DIRECTION INDICATORS

WARNING: FIRST PROGRAMM THE CENTRAL UNIT SUITABLE FOR THE DESIRED CONTROL (negative control on one wire, standard setting), THEN SET THE CONNECTIONS TO AVOID ACCIDENTAL SHORT CIRCUITS.

STANDARD setting: BY A SINGLE CONTROL ON ONE WIRE with starting and final blinking IMPULSE.

In some cars models, this function allows to control simultaneously by a single wire all direction indicators lamps.

- pin 2 - **Green/Red** wire. **WARNING:** insulate separately.
- pin 1 - **Green** wire to connect to any direction indicators lamp (feedback).

WARNING: if not used, insolate it separately.

Suggested connection that allows to optimize the control (in some vehicles it avoid the direction indicators stop blinking during the alarm cycle if they were already activated).

- pin 13 - **Green/Black** wire **NEGATIVE output, 12 volt, protected. Max 700 mA.**

Connect to the direction indicators single simultaneous control wire (usually behind the BLINKER switch).

WARNING:

- Set the suitable control mode: for example **CONTINUOUS** control (continuous signal during the blinking) or **STARTING AND ENDING IMPULSE SIGNALS** (the first one activates the blinking the latter cut it off).
- The system activating / deactivating optical signalling can not always be activated or could give a blinks number different from the standard setting.

BY AN INTERNAL RELAY USUAL CONNECTION TO ACTIVATE BY A SPECIFIC PROGRAMMING

- pin 2 - **Green/Red** wire common positive or negative with fuse feeding (at least **20 A**).
- pin 1 - **Green** wire one channel output (links or right side).
- pin 13 - **Green/Black** wire other channel output (links or right side).

For system with **4 or more channels** follow the indicated wiring diagram installing on the lines a suitable diode (maximum current **3A** each lamps).

STATUS SIGNAL NEGATIVE OUTPUT (pin 4 - **Grey** wire - **OUT 4**)

It gives a negative signal when the system is activated.

- Fixed (standard) to activate the satellite protection system or the additional sensor.
- TIMED it can control the windows closing by the optional winding modules.
- EXCLUDIBLE together with the radar sensor to disable modules if the windows are open or you are in the vehicle.

CENTRAL DOORS LOCKING (pin 14 - **Grey/Black** wire - **OUT 1** / pin 17 - **Pink/Black** wire - **OUT 2**)

Direct central locking control in the negative control systems.

It can be combined with the optional **KIT AP / CH** (part number **674980000**) for the universal control of the central locking by means of 2 relays with changeover contacts. Also suitable for controlling the supplementary door motors.

Programmable opening/closing times as for the vehicles equipped with the COMFORT SYSTEM where the windows and the doors are closed using the same wire or as for the pneumatic system (old cars such as AUDI-MERCEDES).

NEGATIVE OUTPUT POSSIBLE TO BE CUT OUT FOR THE ADDITIONAL MODULES

(pin 14 - **Grey/Black** wire - **OUT 1**) If it's not used to control the central locking.

The unit gives the negative signal to feed the additional modules (shock sensor, antilifting) once the system is fully activated.

The output is not present if the system is partially armed, when on board.

ADDITIONAL ALARM OUTPUT (pin 18 - **Brown** wire - **OUT 3**) Negative output when the system alarms.

Fixed (standard) output to activate **SIR 010** / **SIR 060** siren or the satellite system.

The output could be programmed as intermittente to control the claxon by a relay.

ELECTRICAL BREAK (pin 19 / pin 20 - 2 **White** wires)

The **N.C.** contact (**N**ormally **C**losed) of the internal relay with **15A** electrical capacity (max **20A** for 30 seconds) is suitable for the electrical cut off to block the vehicle.

It can disconnect directly the **[+ 50]** (starting motor) in the 12 volts vehicles.

The relay opens the contact allowing the system starting **[+15] ON** after its activation.

MUX OUTPUT (pin 9 - **Purple** wire) to control the **med** immobilizers **MED 30.1** or **MED 30.2**.

STANDARD SETTINGS:

Direction indicators control:	with a SINGLE wire – with IMPULSES
ULTRASONIC SENSORS:	ON - MEDIUM sensitivity - ANTISABOTAGE ON
Alarm activation on door locking:	CUT OUT
PRE-ALARM:	CUT OUT
BUTTONS analogue / CAN inputs:	ON - IN2 = NO instanteneous, negative signal. IN1 = NO delayed 30 sec., negative signal.
Numero des cycles d'alarme des entrée boutons:	1 ALARM CYCLE
Read [+15] by can line (preset vehicles):	ON
STATUS signal:	FIXED , NO CUT OUT
Central doors locking - negative output:	ON
DOOR OPENING / LOCKING time:	0,8 sec. - SINGLE control for closing doors
Activating / deactivating signalings:	Acoustic: ON Original remote control: OFF
ADDITIONAL ALARM output:	FIXED
Automatic activation of the engine lock:	CUT OUT
Engine starting maintain the CHD 400:	CUT OUT
9 SYSTEM:	OPERATING

- **LED/BOUTON** pour signalisations de service, programmations, code d'urgence. Sur ce câble peut être branchée la pris de clé **PCH 403** pour la clé d'urgence **CHD 400** (optionnelle).
- **Capteur radar**. Pour les versions avec radar, brancher le capteur **RAD 4000** ou les exclure définitivement.
- **ANTENNE:** (pin 5 - Fil **Blanc/Noir**) **Non pas couper. Non pas allonger.**  Maintenir étalé, à bonne distance des autres fils et des parties métalliques du véhicule.

ALIMENTATION

- pin 3 - Fil **Rouge** Positif direct sous fusible de **5 A** pour l'alimentation centrale.
- pin 15 - Fil **Noir** Négatif direct de batterie ou à châssis, sur des points prédéfinis par le constructeur du véhicule.
- pin 16 - Fil **Orange** Positif sous clé de contact **[+15]** permanent au démarrage.
ATTENTION: En certains véhicules avec ligne "CAN" [+15] peut être relevé directement par "CAN". VERIFIER SUR LE VEHICULE.

ENTREES BOUTONS PORTES, CAPOT ET COFFRE - Configuration standard.

- pin 8 - Fil **Bleu ciel** - IN 2 entrée **INSTANTANEE** boutons vers négatif (masse).
- pin 7 - Fil **Bleu ciel/Blanc** - IN 1 entrée boutons **RETARDEE** à l'activation (après instantanée), vers négatif.

ATTENTION:

- **SUR LES VEHICULES AVEC LIGNE DE TRANSMISSION DES DONNES "CAN", LES BOUTONS PEUVENT ETRE RELEVES PAR ELLE. VERIFIER SUR LE VEHICULE.**
- A travers l'utilisation d'un PC et du kit de programmation SK PLUS avec logiciel MED PLUS vous pouvez configurer les deux entrées des boutons analogiques IN1 et IN2 à lire notamment: contacts **NO** (normalement ouverts), **NF** (normalement fermés) à la masse ou au positif, **12** ou **24V**.
- Possible a etre exclue. Cette fonction est à utiliser seulement en cas la voiture est en panne en garage.

INTERFACE AVEC LE SYSTEM ORIGINAL DU VEHICULE (pin 10 - Fil **Bleu foncé** / pin 11 - **Bleu foncé/Rouge** / pin 12 - **Bleu foncé/Jaune** / pin 22 - **Jaune** / pin 23 - **Jaune/Rouge** / pin 24 - **Jaune/Bleu ciel**)

Le système relève, par l'aide d'un ou plus des ces fils, soit les signales **analogiques** que les **digitaux** (des lignes sérielles de transmission des données comme "CAN").

Les indications regardantes les programmations d'interface disponibles, les branchements spécifiques, les avertissements et les habilitations possibles de la centrale ou du véhicule sont indiquées dans les diagrammes de connexion véhicules publiés sur le site Internet med www.medautomotive.it.

Il est toujours possible pour l'installateur mettre à jour la centrale avec un nouveau véhicule par l'aide du câble de programmation **KIT SK PLUS**, le PC et le software relatif **SOFTWARE MED PLUS**.

La lecture des boutons relevés par cette ligne peut être délestée par une programmation spécifique.

CLIGNOTANTS

ATTENTION: IL FAUT D'ABORD PROGRAMMER LA CENTRALE POUR LE TYPE DE CONTROL SOUHAITE (commande négatif sur un fil, configuration standard) et **APRES EFFECTUER LES BRANCHEMENTS POUR EVITER DES COURT-CIRCUITS ACCIDENTALS.**

Configuration STANDARD: PAR UN COMMANDE UNIQUE SUR UN FIL SEUL avec IMPULSION de début et de fin clignotement.

Sur les voitures déjà prédisposées la fonctionne permet de contrôler simultanément avec un seul fil toutes les lampes des clignotants.

- pin 2 - Fil **Vert/Rouge** - **ATTENTION: à isoler séparément.**
- pin 1 - Fil **Vert** - à brancher à n'importe quelle lampe des clignotants (Feedback).
ATTENTION: si on ne l'utilise pas isoler le séparément.
Branchement conseillé qui permet d'en optimiser le control (sur quelques véhicules il permet d'éviter que les clignotants s'étendent pendant le cycle d'alarme s'ils étaient déjà fonctionnant).
- pin 13 - Fil **Vert/Noir** - **sortie NEGATIVE, 12 Volt, protégée. Max 700 mA.**
Brancher le au fil unique de commande simultanée des clignotants (normalement derrière l'interrupteur du BLINKER).

ATTENTION:

- Configurer la modalité de commande correcte: par exemple commande CONTINU (signal constant pour toute la durée du clignotement ou modalité avec IMPULSION de début et de fin du clignotement (le premier impulsion active le clignotement, le successif le coupe).
- Il n'est pas possible activer toujours les signalisations optiques de branchement/débranchement de l'alarme ou ils peuvent donner un numéro de clignotements différent de la configuration standard indiquée.

PAR RELAI INTERNE - BRANCHEMENT USUAL - AACTIVER PAR UNE PROGRAMMATION SPECIFIQUE

- pin 2 - Fil **Vert/Rouge** alimentation commune positive ou négative avec fusible (de **20 A** au mois).
- pin 1 - Fil **Vert** sortie pour un canal (côté droite ou gauche).
- pin 13 - Fil **Vert/Noir** sortie pour l'autre canal (côté droite ou gauche).

Pour les systèmes avec 4 ou plus canaux suivre le schéma indiqué dessus en installant une diode apte sur les lignes (courent maxime de **3A** pour chaque lampes).

SORTIE NEGATIVE DU SIGNAL D'ETAT (pin 4 - Fil Gris - OUT 4)

Elle donne un signal négatif lorsque le système est armé.

- Fixe (configuration standard) - Pour activer le système de protection satellitaire ou le capteur de choc.
- Temporisé il peut commander la lève vitres par les modules lève-vitres optionnels.
- Désactivable pour activer un capteur supplémentaire uniquement si les glaces sont fermées et en l'absence de personnes ou d'animaux à bord.

Quant il est temporisé or désactivable on l'exclut avec l'exclusion momentanée du capteur radar.

FERMETURE CENTRALISEE (pin 14 - Fil Gris/Noir- OUT 1 / pin 17 - Fil Rose/Noir - OUT 2)

Control direct fermeture centralisée pour systèmes à control negatif.

Il peut être combiné avec le module optionnel **KIT AP / CH** (ref. **674980000**) pour le contrôle universel du verrouillage central au moyen de 2 relais avec contacts inverseurs.

Convenable également pour le contrôle des moteurs supplémentaires des portes.

Temps d'ouverture / fermeture programmables comme indiqué pour les véhicules avec SYSTEM CONFORT de lève vitres par le même fil de fermeture portes ou le système pneumatique (par exemple les vieilles voitures AUDI - MERCEDES).

SORTIE NEGATIVE POUVANT ETRE EXCLUE POUR LES MODULES SUPPLEMENTAIRES

(pin 14 - Fil Gris/Noir - OUT 1) **S'elle n'est pas utilisée pour commander la fermeture centralisée.**

La centrale donne le signal négatif pour activer les modules supplémentaires (capteur de chocs, anti-soulèvement) lorsqu'on active le système totalement.

La sortie n'est pas presente si le système est activé partiellement.

SORTIE SUPPLEMENTAIRE D'ALARME (pin 18 - Fil Marron - OUT 3) Sortie négative en alarme.

Fixe (configuration standard) pour activer une sirène auxiliaire (par exemple la sirène **SIR 010 / SIR 060**) ou le système satellitaire.

Elle peut être programmée comme intermittente pour commander le klaxon du véhicule (par le relais).

COUPURE DE COURANT (pin 19 / pin 20 - 2 Fils Blancs)

Le contact **N.F.** Normalement Fermé du relai interne avec une débit continue de **15 A** (maximum **20 A** pour 30 seconds) est apte a effectuer une interruption de courant électrique pour immobiliser le véhicule et il peut couper directement le **[+50]** (démarrreur) sur le véhicule à 12 Volts.

Le relais ouvre contact en permettant le démarrage **[+15] ON** lorsque le système est armé.

SORTIE MUX (pin 9 - Fil Violette) Pour piloter les anti-démarrages **MED 30.1** ou **MED 30.2**.

VALEURS STANDARD PROGRAMMEES

Commande clignotants: Avec fil UNIQUE (BLINKER)

Capteur RADAR:

Avec IMPULSIONS

ACTIVE - Sensibilité MOYENNE

Anti-sabotage ACTIVE

ACTIVATION alarme a la fermeture des portieres:

EXCLU

PRE-ALARME:

EXCLU

Entrée analogique / CAN BOUTONS:

ACTIVES - IN2 = NO instantanée, negatif

IN1 = NO retardée de 30 sec., negatif

Numero des cycles d'alarme des entrées boutons:

1 cycle d'alarme

Lecture [+15] par can (véhicules prédéfinis):

ACTIVE

Signal d'ETAT:

FIXE, no EXCLU

Sortie negative fermeture centralisee:

ACTIVE

Temps d'OUVERTURE / FERMETURE portes:

0,8 secondes

commande SIMPLE de fermeture porte

Signalisations d'activation / désactivation:

Sonores: ACTIVE

Clignotants du telecommande d'origine: EXCLU

Sortie d'ALARME SUPPLEMENTAIRE:

FIXE

Activation automatique coupure moteur:

EXCLU

Démarrage du moteur à maintenir la clé CHD 400:

EXCLU

SYSTEME:

EN SERVICE

- **LED/TECLA** para señalizaciones de servicio, programaciones, código de emergencia. **ESPAÑOL**
La toma **PCH 403** para la llave de emergencia **CHD 400** (opcional) puede conectarse con este cable.
- **Sensores radar.** En las versiones con radar, conectar los sensores **RAD 4000**, o bien excluirlos definitivamente.
- **ANTENA:** (pin 5 - Conductor **Blanco/Negro**) **No cortar. No alargar.** 
Mantenerlo extendido, distante de los otros conductores y de las partes metálicas del vehículo.

ALIMENTACIÓN

- pin 3 - Conductor **Rojo** Positivo directo, con un fusible de **5A** para alimentación central.
- pin 15 - Cable **Negro** Negativo directo procedente de la batería o dirigido al bastidor, en puntos predefinidos por el fabricante del vehículo.
- pin 16 - Cable **Naranja** Positivo bajo el salpicadero [+15] permanente durante el arranque.

ATENCIÓN: En algunos vehículos con línea CAN el [+15] puede ser detectado directamente mediante CAN. COMPROBARLO EN EL VEHÍCULO.

ENTRADAS TECLAS DE PUERTAS, CAPÓ Y MALETERO - Configuración estándar.

- pin 8 - Conductor **Celeste - IN 2:** Entrada **INSTANTÁNEA** teclas a negativo (masa).
- pin 7 - Conductor **Celeste/Blanco - IN 1:** Entrada **RETARDADA** a la activación (luego instantánea), a negativo.

ATENCIÓN:

- **EN LOS VEHÍCULOS CON LÍNEA DE TRANSMISIÓN DE DATOS “CAN” LAS TECLAS PUEDEN SER DETECTADAS DIRECTAMENTE. COMPROBARLO EN EL VEHÍCULO.**
- Mediante PC, KIT SK PLUS y SW MED PLUS es posible configurar las dos entradas de teclas analógicas **IN1** y **IN2** para leer: contactos **NA** (Normalmente Abiertos), **NC** (Normalmente Cerrados) a **masa** o **positivo**, **12** o **24V**.
- Entradas excluibles separadamente en caso de avería de las teclas o de los sensores auxiliares conectados.

INTERCONEXIÓN DEL SISTEMA ORIGINAL DEL VEHÍCULO (Conductores pin 10 - Azul / pin 11 - Azul/Rojo / pin 12 - Azul/Amarillo / pin 22 - Amarillo / pin 23 - Amarillo/Rojo / pin 24 - Amarillo/Celeste).

El sistema detecta mediante uno o más de estos conductores tanto señales **analógicas** como **digitales** (desde líneas serie de transmisión de datos tipo: “CAN”). Las indicaciones en los programas de interconexión disponibles, las conexiones específicas, las advertencias y las habilitaciones a efectuar en el vehículo o en la central **med** se indican en las fichas de conexión de los vehículos en el sitio Internet **med** www.medautomotive.it. El instalador dispone siempre de la posibilidad de actualizar la central para un nuevo vehículo, mediante el cable de programación **KIT SK PLUS**, el ordenador y el correspondiente **SOFTWARE MED PLUS**. La lectura de las teclas detectadas por la línea CAN se puede excluir separadamente.

INDICADORES DE DIRECCIÓN:

ATENCIÓN: PROGRAMAR ANTES LA CENTRAL PARA EL TIPO DE MANDO DESEADO (mando negativo con un conductor, modo estándar), **LUEGO LLEVAR A CABO LAS CONEXIONES PARA EVITAR CORTOCIRCUITOS ACCIDENTALES.**

Programación ESTÁNDAR: POR MANDO ÚNICO CON UN SOLO CONDUCTOR con IMPULSO de comienzo y fin intermitencia. En los vehículos predisuestos, la función permite accionar con un solo conductor todas las lámparas de los intermitentes a la vez.

- pin 2 - Conductor **Verde/Rojo - ATENCIÓN: Aislar separadamente.**
- pin 1 - Conductor **Verde** - Conectar a cualquiera de las lámparas de los intermitentes (feedback).

ATENCIÓN: Si no se utiliza, aislar separadamente.

Conexión aconsejable, que permite optimizar el mando (en algunos vehículos permite evitar que se apaguen durante el ciclo de alarma, si ya estaban en funcionamiento).

- pin 13 - Conductor **Verde/Negro** - Salida **NEGATIVA**, 12 V, protegida. Máx. 700 mA. Conectar al conductor único del mando simultáneo de los indicadores de dirección (normalmente detrás del interruptor del BLINKER).

ATENCIÓN:

- Seleccionar la modalidad de mando adecuada: ej. Mando **CONTINUO** (señal constante por toda la duración de la intermitencia) o con **IMPULSO** de Comienzo y Fin intermitencia (el primer impulso activa la intermitencia, el siguiente la interrumpe).
- No siempre es posible programar las señales ópticas de activación / desactivación del sistema, es posible que éstas estén compuestas por un número de parpadeos diferente de la programación estándar indicada.

POR RELÉ INTERNO - ACTIVACIÓN CLÁSICA - PARA ACTIVAR MEDIANTE PROGRAMACIÓN ESPECÍFICA

- pin **2** - Conductor **Verde/Rojo** Alimentación común positiva o negativa con fusible (mín. 20 A).
- pin **1** - Conductor **Verde** Salida por un canal (lado derecho o izquierdo).
- pin **13** - Conductor **Verde/Negro** Salida por el otro canal (lado derecho o izquierdo).

Para instalaciones con 4 o más canales, aplicar el esquema introduciendo en las líneas un diodo de valor adecuado (máx. **3A** por cada lámpara).

SALIDA NEGATIVA DE SEÑAL DE ESTADO (pin 4 - Conductor Gris - OUT 4)

Emite una señal negativa con el sistema activado.

- Fija (programación estándar) para activar el sistema de protección vía satélite o un sensor adicional.
- TEMPORIZADA para pilotar el elevallunas mediante los módulos elevallunas opcionales.
- EXCLUIBLE conjuntamente con el sensor RADAR para desactivar los módulos si los vidrios están abiertos y se está a bordo del vehículo.

CIERRE CENTRALIZADO (pin 14 - Conductor Gris/Negro - OUT 1 / Conductor pin 17 - Rosa/Negro - OUT 2)

Mando directo del cierre centralizado para sistemas de mando negativo.

Se puede asociar el módulo opcional **KIT AP / CH** cód. **674980000** para el mando universal del cierre centralizado mediante 2 relés con contactos en intercambio. Adecuado también para pilotar los motores de arranque adicionales. Tiempo de apertura / cierre programables igual que para los vehículos con SISTEMA CONFORT de elevallunas con el mismo conductor de cierre de las puertas y para sistemas neumáticos (ej. antiguos automóviles AUDI - MERCEDES).

SALIDA EXCLUIBLE PARA MÓDULOS ADICIONALES (pin 14 - Conductor Gris/Negro - OUT 1).

Si no se utiliza para el cierre centralizado, puede emitir la señal negativa para alimentar los módulos adicionales (sensor de choque, anti-levantamiento) sólo activando el sistema de manera completa.

La salida no está presente si se activa de manera parcializada, cuando se está a bordo del vehículo.

SALIDA ADICIONAL DE ALARMA (pin 18 - Conductor Marrón - OUT 3) Salida negativa en alarma.

Fija (configuración estándar) para activar una sirena auxiliar (por ejemplo la **SIR 010 / SIR 060**) o el sistema satelital. Puede programarse como intermitente para pilotar la bocina del vehículo (mediante relé).

INTERRUPCIÓN ELÉCTRICA (pin 19 / pin 20 - 2 Conductores Blancos)

Contacto **N.C.** (Normalmente Cerrado) del relé interno con intensidad continua de **15A (20A** máx. durante 30 segundos) adecuado para efectuar una interrupción eléctrica para inmovilizar el vehículo.

Puede interrumpir directamente el **[+ 50]** (motor de arranque) en los vehículos a 12 V.

El relé abre el contacto efectuando un arranque **[+15] ON** con el sistema activado.

SALIDA MUX (pin 9 - Conductor Violeta) Para pilotar los inmovilizadores **MED 30.1** o **MED 30.2**.

VALORES ESTÁNDAR PROGRAMADOS:

Control de los indicadores de dirección:	Conductor único (BLINKER) - Con IMPULSOS
Sensor RADAR:	ACTIVO - sensibilidad MEDIA Anti-sabotaje ACTIVO
Activación de la alarma al cierre de las puertas:	EXCLUIDA
PRE-ALARMA:	EXCLUIDA
Entradas TECLAS analógicas / CAN:	ACTIVAS - IN2 = NA instantáneo, Negativo negativo IN1 = NA retardado 30 s
Ciclos de alarma desde entradas de teclas:	1 CICLO de alarma
Lectura [+15] desde CAN (vehículos predispuestos):	ACTIVO
Señal de ESTADO:	FIJA, no excluible
Mando negativo cierre centralizado:	ACTIVO
Tiempo de APERTURA / CIERRE PUERTAS:	0,8 s - mando cierre puertas INDIVIDUAL
Señal activación / desactivación:	Acústicas: ACTIVAS Ópticas desde mando a distancia original: EXCLUIDAS
Salida ALARMA ADICIONAL:	FIJA
Activación automática del bloqueo del motor:	EXCLUIDA
Arranque del motor exclusivamente con CHD 400:	EXCLUIDO
SISTEMA:	EN SERVICIO

674980000

KIT AP / CH

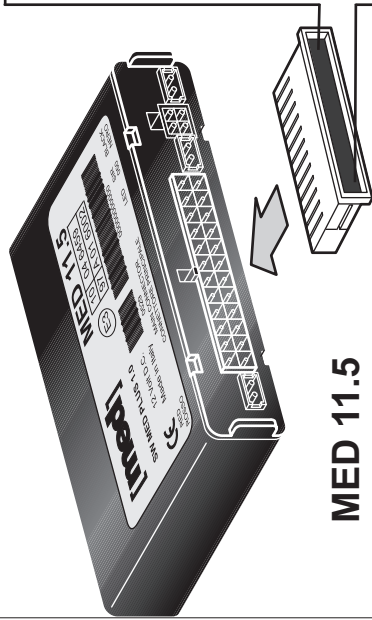

ROSA/NERO
PINK/BLACK

ROSE/NOIR
ROSA/NEGRO

GRIGIO/NERO
GREY/BLACK

GRIS/NOIR
GRIS/NEGRO

ROSSO/BIANCO
RED/WHITE

ROUGE/BLANC
ROJO/BLASCO
24 Volt

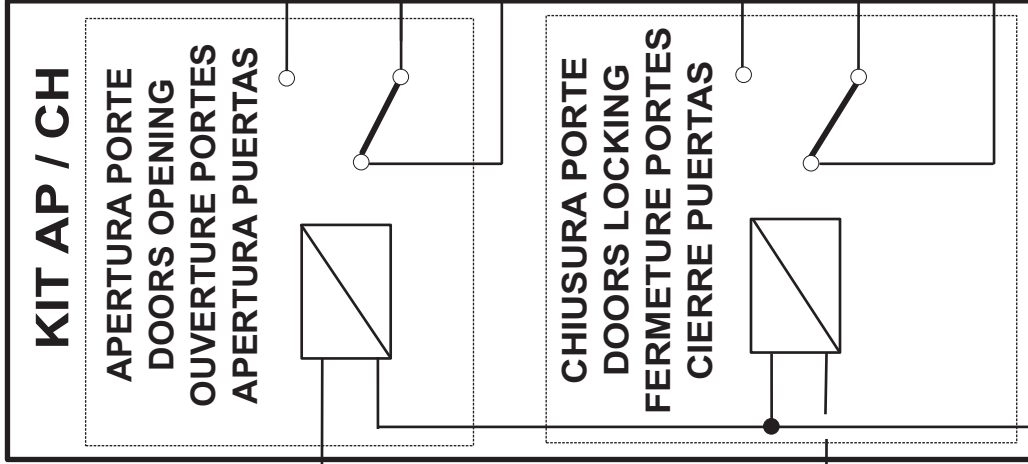
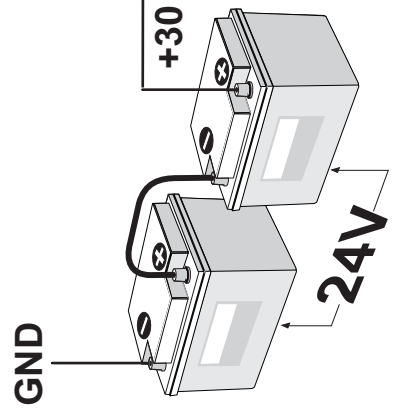

**OPZIONALE - OPTION
OPTIONAL - OPCIONAL**

BLU/ROSSO - BLEU/RED
BLEU FONCE/ROUGE - AZUL/ROJO

BLU/GIALLO - BLUE/YELLOW
BLEU FONCE/JAUNE - AZUL/AMARILLO

BLU - BLU - BLEU FONCE - AZUL

GIALLO/ROSSO - YELLOW/RED
JAUNE/ROUGE - AMARILLO/ROJO

GIALLO/AZZURRO - YELLOW/LIGHT BLUE
JAUNE/BLEU CLAIR - AMARILLO/CELESTE

GIALLO - YELLOW - JAUNE - AMARILLO

ROSSO - RED - ROUGE - ROJO

12 Volt

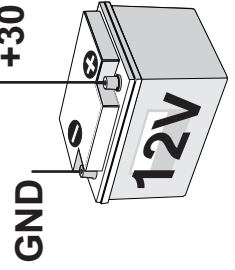



ATTENZIONE - WARNING - ATTENTION - ATENCIÓN



- STACCARE IL NEGATIVO BATTERIA PRIMA DI EFFETTUARE I COLLEGAMENTI.
 - ALIMENTARE IL SISTEMA SOLO AD INSTALLAZIONE COMPLETATA.
 - NON IMPIEGARE “**RUBACORRENTE**” PER LE CONNESSIONI.
 - RISPETTARE I CARICHI MASSIMI INDICATI PER LE USCITE.
 - TUTTI I PULSANTI DI PORTE, COFANO E BAULE DEVONO ESSERE COLLEGATI.
 - SUI VEICOLI A 24 VOLT IMPIEGARE LO SPECIFICO RIDUTTORE DI TENSIONE PER ALIMENTARE LA CENTRALE (+30 E MASSA).
- GLI ALTRI COLLEGAMENTI POSSONO ESSERE EFFETTUATI A 24 VOLT.
- NELLO SCHEMA SOTTOSTANTE SONO RIPORTATI DEI COLLEGAMENTI AD ESEMPIO.

- DISCONNECT THE BATTERY NEGATIVE POLE BEFORE MAKING POWER CONNECTIONS.
- POWER THE SYSTEM ONLY WHEN THE INSTALLATION HAS TERMINATED.
- DO NOT USE “**POWER TAP**”.
- DO NOT EXCEED MAXIMUM LOADS INDICATED FOR THE OUTPUTS.
- ALL DOORS, BONNET AND BOOT BUTTONS MUST BE CONNECTED.
- ON 24-V VEHICLES USE THE SPECIFIC TRANSFORMER TO POWER THE UNIT (+30 AND GROUND). THE OTHER CONNECTIONS CAN BE MADE AT 24 VOLTS.
- IN THE DIAGRAM BELOW ARE SHOWN CONNECTIONS AS EXAMPLE.

- DEBRANCHER LE NEGATIF BATTERIE AVANT DE PROCEDER AUX BRANCHEMENT ELECTRIQUES.
- METTRE SOUS TENSION LE SYSTEME UNIQUEMENT APRES AVOIR TERMINE L'INSTALLATION.
- NE PAS REALISER D'EPISSURES POUR LES BRANCHEMENTS.
- VEUILLEZ A RESPECTER LES CHARGES MAXIMUM POUR LES SORTIES.
- TOUS LES BOUTONS DE PORTIERES, CAPOT ET COFFRE DOIVENT ETRE BRANCHES.
- SUR LES VEHICULES A 24 V UTILISER LE REDUCTEUR DE TENSION APTE POUR ALIMENTER LA CENTRALE (+30 ET MASSE) LES AUTRES BRANCHEMENTS PEUVENT ETRE EFFECTUES A 24 V.
- DANS LE SCHEMA CI-DESSOUS TROUVEZ UN EXEMPLE DE BRANCHEMENT.

- QUITAR EL POLO NEGATIVO DE LA BATERÍA ANTES DE EFECTUAR LAS CONEXIONES.
 - ALIMENTAR EL SISTEMA ÚNICAMENTE CUANDO LA INSTALACIÓN ESTÉ TERMINADA.
 - NO EMPLEAR “**ROBA CORRIENTES**” PARA LAS CONEXIONES.
 - RESPETAR LAS CARGAS MÁXIMAS INDICADAS PARA LAS SALIDAS.
 - TODAS LAS TECLAS DE PUERTAS, CAPÓ Y MALETERO DEBEN ESTAR CONECTADAS.
 - EN LOS VEHÍCULOS DE 24 V UTILIZAR EL REDUCTOR DE TENSIÓN ESPECÍFICO PARA ALIMENTAR LA CENTRAL (+30 Y MASA).
- LAS OTRAS CONEXIONES SE PUEDEN EFECTUAR A 24 V.
- EN EL SIGUIENTE ESQUEMA FIGURAN ALGUNAS CONEXIONES A MODO DE EJEMPLO.

Tutti i diritti riservati. © 2015 AEB S.p.A. a socio unico.
Con riserva di modifiche e di indicazioni errate.
Tous droits réservés. © 2015 A.E.B. S.p.A.
Sous réserve de modifications et d'indications erronées.

All rights reserved. © 2015 AEB S.p.A. a single member Company.
Subject to changes and incorrect information.
Todos los derechos reservados. © 2015 AEB S.p.A. Socio único
Con reserva de modificaciones y fe de erratas

Cod. 190.100.666 - Rev. 03 del 16/04/2015 - Printed in Italy

COMPANY
WITH QUALITY SYSTEM
CERTIFIED BY
BUREAU VERITAS
ISO 9001:2008

A.E.B. S.p.A. a socio unico / a single member Company - Via dell'Industria, 20
42025 - Corte Tegge - Cavriago (RE) - Italy
med è una divisione di / a division of A.E.B. S.p.A. www.medautomotive.it
Ph.+39 0522 494486 - Fax +39 0522 494410 - e-mail: service@medautomotive.it

